

Pryda Timber Connectors

Catalogue

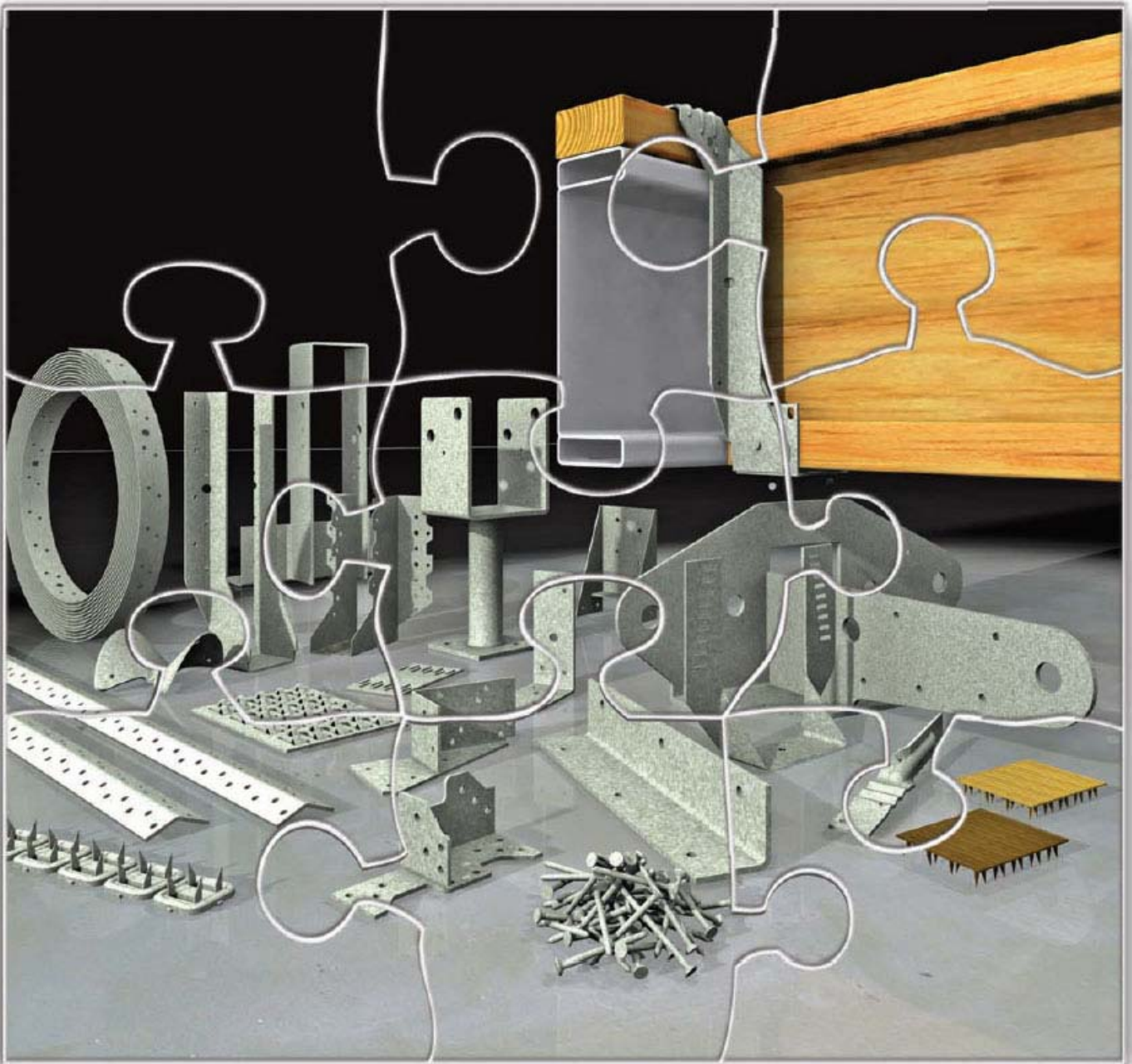

Pryda Catalogue

Timber Connectors

1 November 2013

HOW TO ORDER	2
TABLE OF CONTENTS	3
TERMS AND CONDITIONS	4 - 5
PRICE LIST	7 - 28
REFERENCE SECTION	29 - 31

CUSTOMER CARE

1300 657 052

Pryda Australia

A Division of ITW Australia Pty Ltd. ABN 63 004 235 063

Victoria – Head Office

2-10 Nina Link Dandenong VIC 3175
Postal Address: Locked Bag 1407 Dandenong South VIC 3164
Telephone: (03) 9554 7001 Facsimile: (03) 9554 7000
Sales Facsimile: (03) 9554 7070 or 1300 657 054
Email: sales@pryda.com.au Web: www.pryda.com.au

New South Wales

47-55 Williamson Road, Ingleburn, NSW 2565
Telephone: (02) 9605 0000 Facsimile: (02) 9605 0011
Email: sales@pryda.com.au

Queensland

16-26 Wentworth Road, Banyo QLD 4014
Telephone: (07) 3902 3434 Facsimile: (07) 3902 3444
Email: sales@pryda.com.au

Tasmania / South Australia

All enquiries to Victoria – Head Office.
Telephone: 1300 657 052 Sales Facsimile: 1300 657 054
Email: sales@pryda.com.au

Western Australia / Northern Territory

All enquiries to Victoria – Head Office.
Telephone: 1300 657 052 Sales Facsimile: 1300 657 054
Email: sales@pryda.com.au

By Phone

Our Customer Care staff can efficiently take your order over the phone by calling our national number: 1300 657 052 or your local state office.

By Facsimile

To order by facsimile, complete your Purchase Order(s) by hand or using the Pryda Price List software and fax it to our national number: 1300 657 054 or your local state office.

By Mail

For mail orders, send them to your nearest branch office. Address details appear on page 1.

By Email

Orders can be sent electronically via Pryda's Price List Software. Orders can also be emailed to sales@pryda.com.au or your local state office.

Via your Representative

If you would like Pryda to help you place orders, our Sales Representative can call at your business on a cycle suitable to your needs. Ring your nearest branch to arrange.

Delivery

Our customer service level is for delivery no later than 2 business days from order, direct to metro customer premises or country customer transport depot. Whenever possible, orders will be delivered the next business day. Please advise our Customer Care if you have special delivery requirements.

Literature

Pryda Product Guides are available on request and can be downloaded from the Product Information > Design Guides page on the website:

www.pryda.com.au

Merchandising Aids

Various merchandising systems are available on loan to stockists of Pryda products. Pryda®, Knuckle® and Claw Nail® are registered trademarks of Pryda Australia.

GST

Prices quoted in this directory do not include Goods and Services Tax (GST) but are subject to this tax.

E & OE

While every effort is made regarding the accuracy of this Price List, Pryda is not responsible for any errors or omissions.

Pryda Price List Software

Customers can obtain a free copy of the Pryda Price List software for easy sales ordering and for keeping records of sales. Pryda representatives can assist with installation and use of this software and can upload company's sales discounts into the database so that accurate costing is obtained. The program also includes the latest Pryda Product Guides, allowing users to keep up to date with changes.

Contents

Angle Brace	7	Multigrips & Minigrips	10
AnkaScrews	24	Multigrips- Stainless Steel	28
Anti Crush Plate	20	Nail-on Plates	18
Bin Straps	19	Nails - Timber Connector	24
Barge Angles	22	Pergola Angles	20
Batten Straps	8	Pole Cats	19
Beam Hangers	15	Post Anchors	23
Board Fix	21	Pryda Fix	21
Bolts	27	Pryda Hitch	10
Bottom Plate Anchor	8	Pryda Hold-Down Bracket	9
Collated Nails	25	Pryda Shear Connector	7
Collated Staples	26	Pryda Truss Spacer	20
Connector Plate	19	Purlin Cleats	10
Corner Plate	19	Self Drilling Screws	27
Corrugated Fasteners	26	Set Screws & Washers	27
Cyclone Straps	8	Shade Fix	21
Cyclonic Grips	8	Shunt Plates	19
Dynabolts	24	Speedbrace	7
Fascia Support	20	Stainless Steel Products	28
Foil Fix	21	Strap Brace & Tensioners	7
Framing Brackets	12-13	Strap Brace & Tensioners - Stainless	28
Framing Brackets – Stainless Steel	28	Strap Nails	18
High Capacity Tie Down Kits	9	Stud Ties	10
Hip Support Bracket	16	Tools	26
Hoop Iron & Strapping	22	Triple Grips	11
I-Joist Hanger Cross Reference Guide	31	Truss & Joist Boots	16
I-Joist Hangers	14-15	Truss Boots - Bolt Kits	27
Joist Boots	16	Truss Boots - Heavy Duty	16
Joist Strap	9	Truss Boots - Multifix	16
Knuckle Nailplates	17	Truss Boots - Screws	27
Log Support	20	Truss Tie	11
Maxi Brace & Mini Brace	7	Unitie	11
Merchant Pack Index	30	Universal Heavy Duty Angle	21
Mininail	18	Washers	27
Mitre Plates	9		

Contents by Category

Bracing	7	Hangers & Truss Boots	12-16
Brackets & Fixes	20-21	Nailplates	17-19
Builders Hardware	22	Post Anchors	23
Connectors & Tie Downs	8-11	Reference Section	29-31
Fasteners	24-27	Stainless Steel	28

Terms & Conditions

A. Terms and Conditions of Sale & Supply

The Terms and Conditions of Sale & Supply set out in this document (**Terms and Conditions**) represent the only terms and conditions authorised and accepted by Pryda, and shall apply to form part of any contract arising from any order placed by the Customer and accepted by Pryda when Pryda commences fulfilling that order.

B. Definitions

'Pryda' means Pryda Australia – a Division of ITW Australia Pty Ltd (ABN 63 004 235 063).

'Customer' means any person to whom Pryda has agreed to supply Goods.
'Goods' means the goods, including Services, which Pryda has agreed to supply to the Customer.

'Services' means any services requested by the Customer, including technical advice and use of software.

'FIS' means free into store deliveries to Sites within the Metropolitan area or Metropolitan nominated carrier to areas outside Metropolitan.

'Site' means owned/leased property of the Customer. For Customers with multiple Sites, Sites must be greater than 1 kilometre apart.

C. Offer and Acceptance

Any quotation made by Pryda is not an offer to sell or to provide Goods and no order given in pursuance of any quotation shall bind Pryda until accepted by it by commencing to fulfil that order. All orders are subject to acceptance by Pryda within 30 days of receipt by it of the Customer's order and these Terms and Conditions shall be deemed to be incorporated in any agreement between Pryda and the Customer. Any terms and conditions contained in any order, offer acceptance or other document of the Customer and all representations, statements, terms, conditions and warranties (whether implied by statute or otherwise) not embodied herein are expressly excluded to the fullest extent permitted by law. The Customer's acceptance of Goods or Services ordered in a purchase order shall constitute its acceptance of these Terms and Conditions.

D. Price/Payments

Unless otherwise expressly agreed by Pryda in writing beforehand all Goods will be charged for at, and the Customer will pay, Pryda's prices ruling for such Goods at the date or dates of order. If a raw material, component, or service provider raises its prices, or imposes a surcharge on Pryda, or any tax is imposed or increased in connection with the supply of any Goods or Services by Pryda (including any carbon or emissions related tax), Pryda reserves the right to increase prices and the Customer agrees to accept such price increase.

The Customer shall make payment to Pryda within thirty (30) days after the end of the month in which the Goods are delivered, unless expressly agreed otherwise. In addition to and without limiting Pryda's other remedies for late payment, Pryda is entitled to charge and the Customer is liable to pay interest on any payment that is overdue calculated at a rate of 15% per annum from the date payment is due up to and including the date of payment in full of the due amount (including any interest incurred).

Prices are subject to change without notice.

A \$50 surcharge will apply to orders under \$250 at the discretion of Pryda. Surcharge or order value can be changed without notice.

Pryda reserves the right at its sole discretion to alter at any time its payment terms with the Customer.

Pryda reserves the right to offset any amounts receivable from the Customer against any amounts payable to that Customer or any company affiliated with the Customer or any Related Body Corporate (as that term is defined in the *Corporations Act 2001*) of the Customer. This right exists irrespective of the date the liability has been created or debt incurred with Pryda.

E. Delivery

(a) Unless otherwise agreed in writing, any variation in quantities shipped over or under the quantities ordered (not to exceed 10%) shall constitute compliance with the Customer's order and the stated price per item will continue to apply.

(b) Pryda will make all reasonable efforts to deliver the Goods to the Customer on the agreed date(s), but shall be under no obligation or liability to the Customer for any delays in or failing to comply with delivery dates if such delay or non-compliance is due to causes or events referred to in Clause O or where caused or contributed to by any act or omission by or on behalf of the Customer.

(c) Delivery shall be effected upon:

- (i) physical delivery of the Goods to the address requested by the Customer; or
- (ii) pick up by Customer; or
- (iii) physical delivery to the Customer's nominated carrier.

Notation by Pryda's carrier on the delivery docket shall be conclusive evidence of delivery. The Customer shall be responsible for any loss or damage occurring during unloading of the Goods at the Customer's premises.

(d) If the Customer refuses to accept delivery of the Goods then the risk in the Goods shall, unless otherwise determined by Pryda, pass to the Customer from the time of such refusal. In such an event, Pryda shall be entitled to payment for the Goods as if they were delivered and in addition to any of its rights and remedies (including its right to sell the Goods), Pryda may arrange to store the Goods at the Customer's expense.

(e) Pryda shall not be liable for any losses however caused arising directly or indirectly or consequentially from Pryda's performance or non-performance of any order.

(f) Subject to law, Pryda's liability for faulty workmanship or defective goods is limited to the price of the relevant Goods.

(g) Deliveries are subject to availability of stock and Pryda will not be liable for any loss due to product unavailability.

(h) Pryda will provide the Customer two (2) FIS deliveries per Site per month. Additional deliveries within the month will be charged at \$50 per delivery

F. Property and Risk

(a) Legal and equitable title in all Goods supplied by Pryda to the Customer shall remain vested in Pryda until Pryda has received payment for all monies outstanding due to Pryda for Goods supplied although the Customer shall have the right to sell such Goods in the ordinary course of trade provided that the Customer shall account to Pryda for all payments including payments by third parties in accordance with the Customer's fiduciary relationship.

(b) Goods supplied by Pryda to the Customer in which title remains vested in Pryda shall be held by the Customer as fiduciary bailee of Pryda and shall be stored so that the same are identifiable as Pryda's property and are not commingled with the other property of the Customer or a third party.

(c) Unless otherwise agreed in writing signed by Pryda, all material, equipment, facilities, and special tooling (which term includes but is not limited to tools, jigs, dies, fixtures, moulds, patterns, special taps, special gauges, special test equipment, and manufacturing aids and replacements thereof) used in the manufacture of Goods shall remain the property of Pryda. Any material, tooling, or equipment furnished to Pryda by the Customer shall be and remain the personal property of the Customer with the title to and right of possession remaining in the Customer. The Customer will separately store such property from any other property of Pryda or third parties and in a way that such property is clearly identifiable as property of Pryda. Pryda has the right to access any premises of the Customer from time to time to inspect or remove such property. The Customer shall take all risk in, and be responsible for any loss of or damage to, such property.

(d) Pryda shall have the right to repossess at any time Goods in which title remains vested in Pryda, and to enter the premises of the Customer for such purpose without liability and without prejudice to the pursuit of any other legal remedy available to Pryda.

(e) The risk and liability for loss, damage or destruction, as well as the results of any use or misuse by third parties who may acquire or use the Goods shall pass to the Customer on delivery to or collection by the Customer of the Goods, as referred to in Clause F(d).

G. Security Interest

In consideration for Pryda supplying Goods to the Customer under these Terms and Conditions, the Customer:

(a) agrees to treat the security interest created under these Terms and Conditions as a continuing and subsisting security interest in the relevant Goods with priority over any registered or unregistered general (or other) security and any unsecured creditor (even if the Goods become fixtures before paid for in full);

(b) grants to Pryda a purchase money security interest ("PMSI") as defined in the Personal Property Securities Act 2009 (Cth) ("PPSA") in Goods supplied;

(c) agrees that the PMSI granted herein will continue to apply to any Goods coming into existence or proceeds of sale of Goods or Goods coming into existence;

(d) agrees that the PMSI has attached to all Goods now or in the future supplied to the Customer by Pryda; and

(e) agrees, until title in Goods pass to it, to keep all Goods free and ensure all Goods are kept free of any charge, lien or security interest (as defined in the PPSA) except as created under these Terms and Conditions, and not otherwise deal with Goods in a way that will or may prejudice any rights of Pryda under these Terms and Conditions or the PPSA

(f) Pryda reserves the right to register a financing statement under the PPSA in respect of the Goods. Costs of registering a financing statement (or a financing change statement) will be paid by the Customer. The Customer waives its right to receive a copy of any financing statement, financing change statement or verification statement that is or may be registered, issued or received at any time.

(g) The Customer irrevocably grants Pryda the right to enter any premises or property (without notice) and without being in any way liable to Pryda or any other person if the Customer has cause to exercise any of its rights under the PPSA (and The Customer will indemnify Pryda against any such liability).

(h) It is agreed that (to the extent permitted under the PPSA), the Customer hereby waives its rights under sections 95, 96, 117, 118, 120, 121(4), 123, 125, 126, 128, 129, 130, 132, 134, 135, 142 and 143 of the PPSA.

H. Description and Specification

(a) Whilst every effort is made to ensure their accuracy, the descriptions, illustrations and materials contained in any catalogues, price lists, brochures, leaflets or other descriptive matter provided by or on behalf of Pryda represents the general nature of the item described therein and shall not form any part of any order or agreement or amount to any representation or warranty.

(b) Pryda does not warrant or guarantee and it shall not be a term of any agreement between Pryda and the Customer that any Goods manufactured, constructed or supplied by Pryda which are based in whole or in part upon any designs or drawings or specifications supplied to Pryda by or on behalf of the Customer will achieve any standard or performance or any capacity whatsoever.

I. Product use

The Customer is solely responsible for determining whether any product is fit for a particular purpose and suitable for the Customer's method of application, accordingly, and due to the nature and manner of use of Goods. Pryda is not responsible for the results or consequence of use, misuse or application of its Goods by anyone.

Intellectual Property

(a) All drawings, know-how, designs, specifications, inventions, devices, developments, processes, copyrights and other information or industrial or intellectual property disclosed or otherwise provided to the Customer by Pryda or otherwise subsisting in Goods or Services and all rights therein (collectively, "Intellectual Property") will remain the property of Pryda and will be kept confidential by the Customer. The Customer shall have no claim to, nor ownership interest in, any Intellectual Property and such information, in whatever form and any copies thereof, shall be promptly returned to Pryda upon written request from Pryda. The Customer acknowledges that no license or rights of any sort are granted to the Customer hereunder in respect of any Intellectual Property, other than the limited right to use Pryda's proprietary Goods purchased from Pryda.

- (b) The Customer warrants that any of the Goods manufactured, constructed or supplied by Pryda which are based in whole or in part upon designs, drawings or specifications supplied to Pryda by or on behalf of the Customer shall not infringe any letters, patents or registered designs or any other intellectual property rights of any third party. The Customer shall indemnify and keep indemnified Pryda, its servants and agents against any action, loss, cost, claim, damage or liability of any nature that may be brought against or suffered by Pryda, its servants or agents for any breach of this warranty
- (c) Except as set forth in these Terms and Conditions, Pryda agrees to defend, indemnify and hold the Customer harmless against any claims, costs, damages, liability and expenses resulting from actual patent, trademark, or copyright infringement, misappropriation of confidential information, or violation of any other Intellectual Property right, domestic or foreign, that may arise from the sale of Pryda's proprietary Goods to the Customer as such pertains to the subject matter of these Terms and Conditions (provided those Goods are not modified in any way by the Customer or any other party, and that the Goods are used in the manner intended by Pryda). If a suit or claim results in any injunction or any other order that would prevent Pryda from supplying any part or Good falling under these Terms and Conditions, or if the result of such a suit or claim would, in the reasonable opinion of Pryda, otherwise cause Pryda to be unable to supply such parts or Goods, Pryda shall have the right, at its option, if it so chooses, to do one or more of the following: (i) secure an appropriate license to permit Pryda to continue supplying said parts or Goods to the Customer; (ii) modify the appropriate part or Good so that it becomes non-infringing; (iii) replace the appropriate part or Good with a non-infringing but practically equivalent part or Good; or (iv) if Pryda cannot reasonably accomplish the actions specified in subparagraphs (i) – (iii), then in Pryda's sole discretion, Pryda may discontinue selling the part or Good without any further liability to the Customer.
- (d) If any claim is made by a third party on the basis of which indemnification may be sought under this paragraph, the party entitled to indemnification (the "Indemnified Party") shall give written notice of such claim to the party liable for such indemnification (the "Indemnifying Party") promptly after the Indemnified Party has actual notice of such claim. The Indemnifying Party shall have the right to defend and/or settle such claim at its expense, provided that it does so diligently and in good faith. The Indemnified Party shall cooperate with such defence and/or settlement and shall have the right to participate in (but not to control) such defence and/or settlement at its expense. No settlement shall be entered into unless the Indemnified Party shall be released from all liability for such claim.

K. Confidential Information

All information furnished or made available by Pryda to the Customer in connection with the subject matter of these Terms and Conditions or of the Customer's purchase order shall be held in confidence by the Customer. The Customer agrees not to use such information or disclose such information to others without Pryda's prior written consent. The obligations in this paragraph will not apply to any information which: (a) at the time of disclosure was or thereafter becomes, generally available to the public by publication or otherwise through no breach by the Customer of any obligation herein; (b) the Customer can show by written records was in the Customer's possession prior to disclosure by Pryda; or (c) is legally made available to the Customer by or through a third party having no direct or indirect confidentiality obligation to Pryda with respect to such information.

- L. Cancellation** Pryda reserves the right to cancel any purchase orders or releases thereunder, or terminate any agreement relating to the purchase of of the order had the order not been cancelled, varied or suspended.

M. Warranty

- (a) Where any applicable legislation implies any term, condition or warranty into the relationship between Pryda and the Customer or into a contract of sale between Pryda and the Customer in relation to the sale or supply of Goods, or otherwise gives the Customer a particular remedy against Pryda, and the legislation or any legislation avoids or prohibits provisions excluding or modifying the application of, or exercise of, or liability under such term, condition, warranty or remedy, then that term, condition, warranty or remedy shall be deemed to be included in these Terms and Conditions, or, as the case may be, apply to the relationship. However, Pryda's liability for any breach of such term, condition or warranty or under such remedy shall be limited, at Pryda's option, in any one or more of the ways permitted by the legislation including, where so permitted:
 - (i) If the breach relates to any Goods (other than Services) to:
 - (a) the replacement of those Goods or the supply of equivalent Goods;
 - (b) the repair of those Goods;
 - (c) the payment of the cost of replacing those Goods or acquiring equivalent Goods; or
 - (d) the payment of the cost of having those Goods repaired; and
 - (ii) if the breach relates to any Services to:
 - (a) the supplying of those Services again; or
 - (b) the payment of the cost of having those Services supplied again.
- (c) Except as expressly provided in) Paragraph M(a) above, all terms, conditions, warranties, undertakings, inducements and representations, whether express or implied, statutory or otherwise, relating in any way to any Goods supplied by Pryda are excluded. Without limiting any other provision of these Terms and Conditions, Pryda will not be under any other liability in respect of any loss or damage (including consequential loss or damage) however caused (whether by negligence of Pryda or any person or otherwise) which may be suffered or incurred or which may arise directly or indirectly in respect of any Goods supplied or not supplied by Pryda.

N. Claims and Returns

- (a) Examination of the Goods shall be made by or on behalf of the Customer, and unless within seven days of delivery of the Goods, the Customer gives written notice that the Goods are not in accordance with the Customer's order(s), the Goods shall be deemed to be in all respect in accordance with the order(s) and the contract, and the Customer shall be bound to accept and pay for the same accordingly.

If the Goods are made to suit specifications provided by the Customer, an error in the specifications will not entitle the Customer to reject the Goods and the Customer shall be liable for the full price of the Goods and any costs involved in altering the Goods.

- (b) Claims by the Customer for credit, other than claims in respect of return of Goods, will not be valid unless made in writing prior to the end of the payment period referred to in Clause D. Claims by the Customer for credit in respect of Goods which are defective or have not been supplied in accordance with these Terms and Conditions must first have prior written approval of Pryda's authorised representative who must be afforded a reasonable opportunity to inspect the Goods and will not be valid unless made within seven days of delivery of the Goods, and the Goods the subject of such claim(s), subsequently being returned to Pryda with a signed Return of Goods Authority on carrier(s) and to warehouse(s) nominated by Pryda.
- (c) Pryda is under no obligation to accept claims for Goods returned which have been used, damaged or altered in any way. All Goods must be returned in their original packaging.
- (d) Goods returned will be subject to a 25% rehandling charge. Goods are to be returned at the Customer's expense or costs of collection will be deducted from the amount to be credited.
- (e) Except as expressly provided herein, Pryda will neither accept return of Goods, nor be responsible for its destruction.

O. Excusable Delays

- (a) Pryda shall not be liable for any failure to comply with these Terms and Conditions when such failure is caused by or arises out of any of the following:
 - (i) fire, storm, tempest, earthquake, inevitable accident or other act of God;
 - (ii) any act of public enemy;
 - (iii) any act of the government of the Commonwealth of Australia or any State or Territory thereof or any local government or council or any instrumentality or authority, which has the necessary power to or otherwise does prevent or delay the due performance of any or all of the requirements and/or terms and conditions of any order placed by the Customer;
 - (iv) any act of any person engaged in subversive activity or sabotage;
 - (v) epidemics or quarantine restrictions;
 - (vi) strikes, slow-downs, lockouts or labour stoppages or disputes of any kind or freight embargoes;
 - (vii) any shortfall, delay or failure to supply by any of Pryda's suppliers; or
 - (viii) any other cause or event whatsoever which is beyond the control and without the fault or negligence of Pryda.
- (b) In the event of a failure by Pryda to perform or carry out any or all of the Terms and Conditions hereof arising from any of the causes or events set forth in sub-paragraph (a) of this paragraph the Customer shall be entitled to obtain the Goods contracted for supply elsewhere for the duration of such failures and to reduce pro rata, and without any obligation to Pryda, the quantity or amounts of the Goods contracted for supply with the Customer.

P. Termination

- (a) Without prejudice to any of its other rights, Pryda may at its option (and without liability or notice) require satisfactory security or payment in cash before delivery notwithstanding the terms of payment specified herein or agreed or may terminate an order or suspend further deliveries:
 - (i) if the Customer shall commit any breach of this or any other contract with Pryda including failure to make any payments on the due dates;
 - (ii) if being an individual, the Customer shall die or have a receiver appointed over his assets or becomes unable to pay his debts as and when they fall due or shall cease or threaten to cease to conduct business;
 - (iii) if being a company, the Customer is or becomes an externally administered body corporate (within the meaning of the *Corporations Act 2001*) or a controller (within the meaning of the *Corporations Act 2001*) enters into possession or takes control of all or any of the Customer's assets or undertaking or if the Customer is or becomes insolvent (within the meaning of the *Corporations Act 2001*) or ceases or threatens to cease carrying on business;
 - (iv) if the Customer compounds with or negotiates for any composition with its creditors or permits any judgment against it to remain unsatisfied for seven days;
 - (v) if any distress execution or other legal process shall be levied upon the Customer; or
 - (vi) if in Pryda's sole judgment, the financial position of the Customer is or becomes unsatisfactory or the Customer becomes unable to pay its debts as and when they fall due.
- (b) Upon termination or suspension of deliveries Pryda may recover and resell the Goods and the Customer hereby grants to Pryda a licence for access to the Customer's premises for the purposes of such recovery and to examine the Goods

Q. Taxes

The Customer must in addition to the price, pay the amount of all fees, duties, licences, tariffs, GST (as defined in the *A New Tax System (Goods and Services Tax) Act 1999*) and all sales, use, privilege, occupation, excise, value added, consumption or similar taxes, federal, state, local or foreign, which Pryda is required to pay or collect in connection with the Goods or Services sold to the Customer to the intent that the prices for the Goods are paid to Pryda as net amounts clear of such tax. Failure by Pryda to collect any such fees or taxes shall not affect the Customer's obligations hereunder and the Customer shall fully defend, indemnify and hold harmless Pryda with respect to such tax obligations.

R. Limitation of Actions

To the extent permitted by law, any cause of action for any alleged breach of these terms and conditions by Pryda shall be barred unless commenced by the Customer within one (1) year from the accrual of such cause of action.

S. Variation

Any variation to any order(s) placed by the Customer for Goods will only be effective if signed in writing by an authorised representative of Pryda. Pryda

reserves the right to vary these Terms and Conditions at any time, and these Terms and Conditions (as varied) will then apply to all order(s).

T. Waiver

Failure by Pryda to insist upon strict performance of any term or condition hereof shall not be deemed a waiver thereof or of any rights which Pryda may have and shall not, and nor shall any express waiver, be deemed to be a waiver of any subsequent breach of any term or condition.

U. Severability

If any provision herein shall be held to be unlawful or unenforceable, the unlawful or unenforceable provision may be severed from these Terms and Conditions and the remaining provisions shall herein remain in full force and effect,

V. Governing Law

All contracts shall be governed by and construed in accordance with the laws in force in Victoria, Australia.

W. Declaration

Pryda's Goods and Services. Subject to Section 75A of the *Trade Practices Act 1974* and without limiting the entitlement of a consumer to rescind a contract as provided in that Section, any order may only be cancelled, varied or suspended with the consent of Pryda and in the event of such cancellation, variation or suspension, the Customer undertakes to reimburse and indemnify Pryda for any costs, expenses or charges incurred by Pryda in preparation for and in the execution of an order which, without limiting the generality thereof, shall include an amount equal to 50 per centum of the net profits to Pryda of the order had the order not been cancelled, varied or suspended.

1. I/We the undersigned declare that the information provided by me/us in support of this application is true and correct in every particular.
2. I/We agree to be bound solely by your Terms and Conditions as detailed above and I/we further agree that any terms or conditions of purchase that may be incorporated in any order, acceptance of quotation or any other document delivered by me/us shall, unless those terms and conditions are expressly agreed to in writing by your duly authorised representative, have no legal effect.
3. I/We agree that any legal costs incurred by you on a solicitor and own client basis in the recovery of any monies due by me/us shall be recoverable in full from me/us.
4. I certify that I am authorised to sign this application on behalf of the Customer.
5. I acknowledge that these Terms and Conditions are also available via the website 'Pryda.com.au' and can change without notice.

Angle Brace

Product Code	Article & Size	Packed
Pryda Maxi Brace 20 x 18 x 1.2mm (AB)		
AB36	3.6m lengths	Tied Bundles of 10 lengths
AB42	4.2m lengths	Tied Bundles of 10 lengths
AB48	4.8m lengths	Tied Bundles of 10 lengths
Pryda Mini Brace 18 x 16 x 1.2mm (MB)		
MB36	3.6m lengths	Tied Bundles of 10 lengths
MB42	4.2m lengths	Tied Bundles of 10 lengths
MB48	4.8m lengths	Tied Bundles of 10 lengths

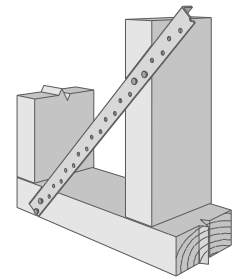

Mini Brace

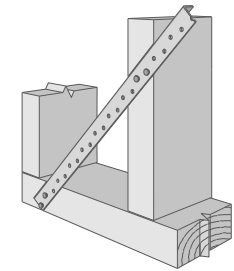

Maxi Brace

Speedbrace (SDB)

Product Code	Article & Size	Packed
Pryda Speedbrace 18.5 x 18.5 x 1.0mm		
SDB36	3.6m lengths	Tied Bundles of 10 lengths
SDB40	4.0m lengths	Tied Bundles of 10 lengths
SDB50	5.0m lengths	Tied Bundles of 10 lengths
SDB60	6.0m lengths	Tied Bundles of 10 lengths

For ease of handling; order Angle & Speed Brace in lots of 20 bundles.
Pryda 35x3.15mm Galvanised Pryda Timber Connector Nails

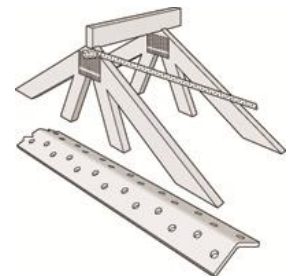

Speedbrace

Strap Brace & Tensioners (SB)

Product Code	Article & Size	Packed
Pryda Strap Brace		
SB083/15	30 x 0.8mm x 15m	1 Coil
SB083/30	30 x 0.8 mm x 30m	1 Coil
SB083/50	30 x 0.8mm x 50m	1 Coil
SB103/30	30 x 1.0mm x 30m	1 Coil
SB103/50	30 x 1.0mm x 50m	1 Coil
SB123/30	32 x 1.2mm x 30m	1 Coil
SB083/3.5	30 x 0.8mm x 3.5m	1000 lengths
SB083/3.5W-500	30 x 0.8mm x 3.5m	500 lengths
SB083/4.0W-500	30 x 0.8mm x 4.0m	500 lengths
SB083/4.5	30 x 0.8mm x 4.5m	1000 lengths

Pryda 35x3.15mm Galvanised Pryda Timber Connector Nails



Strap Brace

Pryda Tensioners (for Strap Brace)		
SBT	6 per pack x 5 packs – 30 in Carton (Includes Wing Nuts & "T" Bolts)	
SBT30N	6 per pack x 5 packs – 30 in Carton (includes Hex-head bolts)	
SBT100	100 per pack (Includes Wing Nuts & "T" Bolts)	
SBT100N	100 per pack (includes Hex-head bolts)	



SBT



SBT100N

Pryda Shear Connector (PH)

Product Code	Article & Size	Packed
Pryda Shear Connector		
PSC	300 x 30 x 1.0mm	200

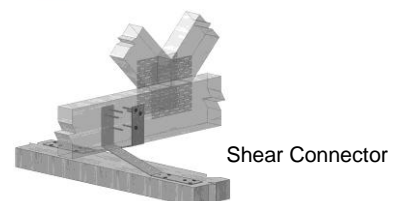

Shear Connector

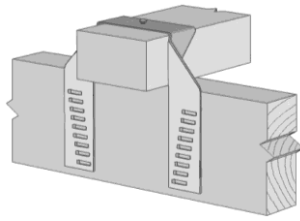

Batten Strap



Batten Straps (BS)

Product Code	Article & Size	Packed
Pryda Batten Straps 1.0mm		
BS70	70 x 30mm (Built in Nails)	70
BS90	90 x 30mm (Built in Nails)	60
Pryda 35 x 3.15mm Galvanised Timber Connector Nails		

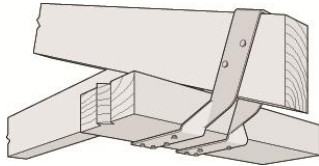

Cyclone Strap

Cyclone Straps (QH)

Product Code	Article & Size	Packed
Pryda Cyclone Strap 1.0mm		
QHS4	400 x 32mm	80
QHS6	600 x 32mm	80
QHS9	880 x 32mm	25
Pryda Cyclone Strap 1.2mm		
QHS9/2	880 x 32mm	25
Merchant Packs – Individually Bar-coded		
MPQHS4	400 x 32mm	80
MPQHS6	600 x 32mm	80
Pryda 35 x 3.15mm Galvanised Timber Connector Nails		

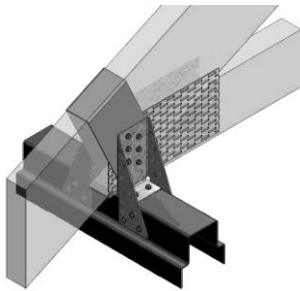

Cyclonic Grip



Cyclonic Grips (HC)

Product Code	Article & Size	Packed
Pryda Cyclonic Grips		
PCG	135 x 55 x 58 x 1.6mm	50
PCG90	119 x 55 x 92 x 1.2mm	50

High Capacity Tie Down Kits (HC)

Product Code	Article & Size	Packed
Pryda High Capacity Tie Down Kits		
HCTD	150 x 150 x 8mm	10
10 kits of 1 x HCTD plate & 2 x washers		
HCTD/WA	150 x 150 x 8mm	5
5 kits of 1 x HCTD Plate, 2 x over washers, 1 x under washer, 2 x M12 x 250mm threaded rod & 4 x Nylok® nuts		

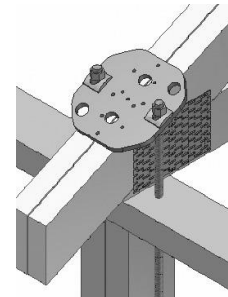

High Capacity Tie Down

Pryda Hold- Down Bracket (CPA)

Product Code	Article & Size	Packed
Pryda Hold-Down Bracket		
MPCPAH	130 x 50 x 47 x 2.0mm	75
Pryda 35 x 3.15mm Galvanised Timber Connector Nails		

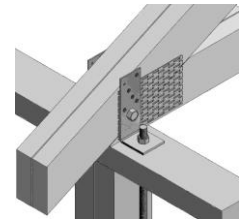

Hold Down Bracket

Joist Strap (GMP)

Product Code	Article & Size	Packed
Pryda Joist Strap		
GJS	162mm long	150
Pryda 35 x 3.15mm Galvanised Timber Connector Nails		

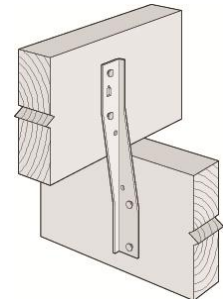

Joist Strap

Mitre Plates (MG)

Product Code	Article & Size	Packed
Pryda Mitre Plates		
MT	78 x 126mm Bent 45°	20
MT15	78 x 126mm Bent Skew (left & right)	10L,10R
Pryda 35 x 3.15mm Galvanised Timber Connector Nails		

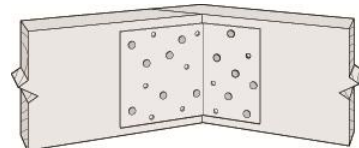

Mitre Plate

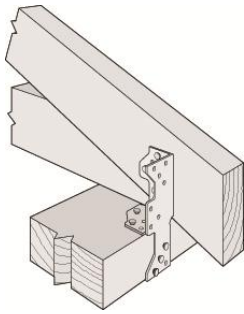

Multigrip

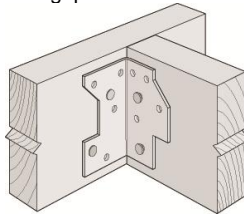

Minigrip

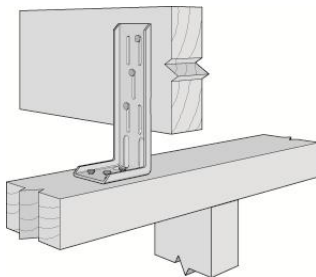

Pryda Hitch

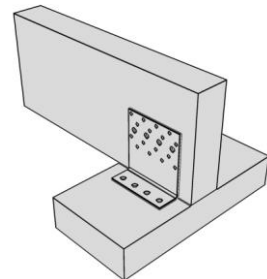

Purlin Cleat

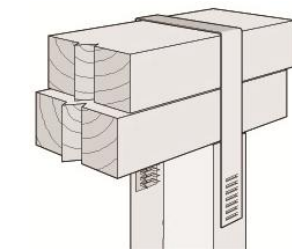

Double Sided Stud Tie

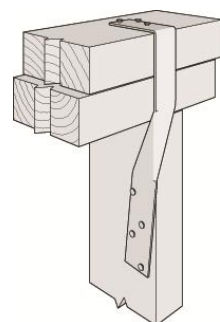

Single Sided Stud Tie

Multigrips & Minigrips (MG)

Product Code	Article & Size	Packed
Pryda Multigrips 1.0mm		
MG	100 x 35mm	200
MGL	132 x 35mm Long Grip Profile	100
Merchant Packs – Individually Bar-coded		
MPMG	Multigrip – 100 x 35mm	100
MPMGS	Minigrip – 57 x 35mm	100
Pryda 35 x 3.15mm Galvanised Timber Connector Nails		

Pryda Hitch (PH)

Product Code	Article & Size	Packed
Pryda Hitch – Internal Wall Hitch		
PHH	Coined 114 x 46 x 38 x 0.8mm	200
PHL	Plain 100 x 44 x 36 x 1.2m	100
PHS	Super Heavy Plain 130x50x47x2.0mm	100
Merchant Packs – Individually Bar-coded		
MPPHH	Coined 114 x 46 x 38 x 0.8mm	100
Pryda 35 x 3.15mm Galvanised Timber Connector Nails		

Purlin Cleat (GMP)

Product Code	Article & Size	Packed
Pryda Purlin Cleat		
NPPC8	80mm wide	25
Pryda 30 x 3.15mm Galvanised Timber Connector Nails		

Stud Ties (ST)

Product Code	Article & Size	Packed
Pryda Stud Ties 1.0mm – Double Sided		
ST3	300 x 25mm	100
ST4	400 x 25mm	80
ST4U70	400 x 25mm Prebent for 70mm timber	80
ST4U90	400 x 25mm Prebent for 90mm timber	80
Pryda Stud Ties 1.0mm – Single Sided		
STS3R	240 x 60mm Right (dimpled)	50
STS3L	240 x 60mm Left (dimpled)	50
STS3HR	240 x 60mm Right (with holes)	50
STS3HL	240 x 60mm Left (with holes)	50
Pryda Stud Ties 1.0mm – Ezi Stud Tie		
MPSST	185 x 65mm	50
STS3R&L: Paslode Screw Shank Nails – D40810		
STS3HR&L: Pryda 35 x 3.15mm Galvanised Timber Connector Nails		

Triple Grips (TG)

Product Code	Article & Size	Packed
Pryda Triple Grips 1.0mm		
TGAR	115 x 60mm, pre-bent-Right (No Nails)	100
TGAL	115 x 60mm, pre-bent-Left (No Nails)	100
Merchant Packs – Individually Bar-coded		
MPTGAR	115 x 60mm, pre-bent-Right (No Nails)	50
MPTGAL	115 x 60mm, pre-bent-Left (No Nails)	50

Pryda 35 x 3.15mm Galvanised Timber Connector Nails

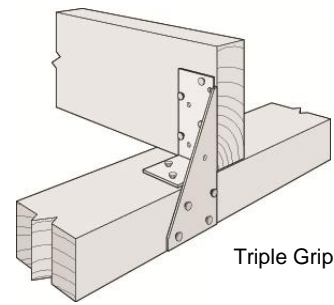

Triple Grip

Truss Tie (TS)

Product Code	Article & Size	Packed
Pryda Truss Ties 1.0mm		
TT	117 x 25mm (50 Left 50 Right per carton)	100

Pryda 35 x 3.15 mm Galvanised Timber Connector Nails

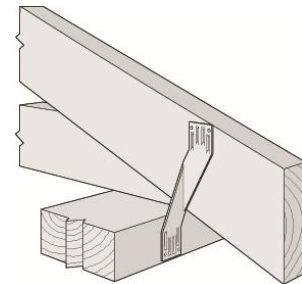

Truss Tie

Unities (UT)

Product Code	Article & Size	Packed
Pryda Long Leg Unitie 1.0mm		
UT/400L	400 x 32mm Left Hand	80
UT/400R	400 x 32mm Right Hand	80
Merchant Packs – Individually Bar-coded		
MPUT/90L	170 x 32mm Left Hand	100
MPUT/90R	170 x 32mm Right Hand	100

Pryda 35 x 3.15mm Galvanised Timber Connector Nails

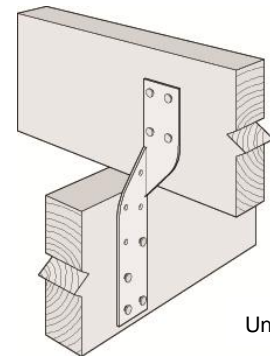

Unities

Framing Brackets

Product Code	Product Internal Dimensions (Width x Height)	Packed
Size – 90mm depth (FB90)		
FB3590	36 x 82mm	45
FB3890	39 x 81mm	45
FB4290	43 x 78mm	45
FB4590	46 x 77mm	45
FB5890	59 x 70mm	45
Size – 120mm depth (FB12)		
FB35120	36 x 116mm	45
FB42120	43 x 112mm	45
FB45120	46 x 111mm	45
FB58120	59 x 104mm	45
Size – 140mm depth (FB14)		
FB45140	46 x 135mm	40
Size – 180mm depth (FB18)		
FB35180	36 x 182mm	30
FB42170	43 x 170mm	30
FB45180	46 x 177mm	30
FB58170	59 x 170mm	30
Size – 220mm depth (FB22)		
FB42220	43 x 218mm	15
FB45220	46 x 217mm	15
FB58220	59 x 210mm	15
Other sizes		
FB65170	65 x 168mm (FB65)	25
FB70200	70 x 195mm (FB20)	25
FB84200	85 x 197mm (FB20)	25
FB90200	90 x 195mm (FB20)	25
Pryda Longreach Floor Truss Hangers		
FB72163	72 x 164mm (FB72)	25
FB94152	94 x 153mm (FB94)	25

All sizes available in Stainless Steel except FB65170, FB72163 & FB94152

Pryda 35x3.15mm Galvanised Pryda Timber Connector Nails

No.12 x35 Type 17 Self drilling screws (WTF12-35)

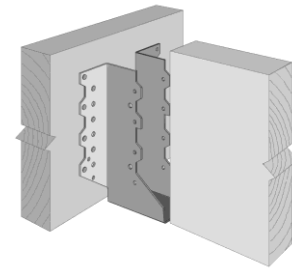

Framing Bracket

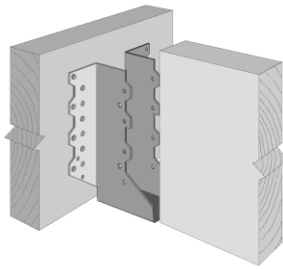

Framing Bracket

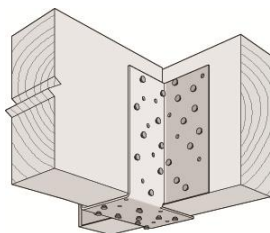

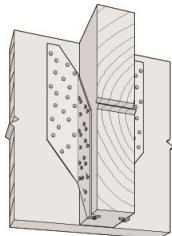

Heavy Duty Joist Hanger



Split Joist Hanger

Framing Brackets - Merchant Packs

Product Code	Product Internal Dimensions (Width x Height)	Packed
Merchant Packs – Individually Bar-coded		
Size – 60mm depth (FB60)		
MPFB3860	39 x 60mm	45
MPFB5060	50 x 54mm	45
Size – 90mm depth (FB90)		
MPFB3590	36 x 82mm	45
MPFB3890	39 x 81mm	45
MPFB4590	46 x 77mm	45
MPFB5090	50 x 75mm	45
Size – 120mm depth (FB12)		
MPFB35120	36 x 116mm	45
MPFB38120	39 x 115mm	45
MPFB45120	46 x 111mm	45
MPFB50120	50 x 109mm	45
Size – 140mm depth (FB14)		
MPFB35140	36 x 140mm	40
MPFB38140	39 x 138mm	40
MPFB45140	46 x 135mm	40
MPFB50140	50 x 133mm	40
Size – 180mm depth (FB18)		
MPFB38180	39 x 181mm	30
MPFB45180	46 x 177mm	30
MPFB50180	50 x 175mm	30
Size – 220mm depth (FB22)		
MPFB50220	50 x 215mm	15
 Pryda 35 x3.15mm Galvanised Pryda Timber Connector Nails  No. 12 x 35mm Type 17 screws (WTF12-35)		

Joist Hangers – Heavy Duty (JH)

Product Code	Article & Size	Packed
Pryda Heavy Duty Joist Hangers 1.2 mm		
JHH58	126 mm – For 59mm Timber	10
JHH65	126 mm - For 65mm Timber	10
JHH75	126 mm - For 75mm Timber	10
JHH100	140 mm - For 95mm Timber	10
Pryda Split Joist Hangers 1.6 mm		
JHHS	5 Right Hand & 5 Left Hand per Carton	10
 Pryda 35x3.15mm Galvanised Pryda Timber Connector Nails		

I-Joist Hangers

Product Code	Article & Size	Packed
Face Mounted (LF)		
LF235/40	41 x 237mm	25
LF297/40	41 x 297mm	25
LF190/45	46 x 189mm	25
LF240/45	46 x 235mm	25
LF300/45	46 x 297mm	25
LF190/50	52 x 189mm	25
LF235/50	52 x 232mm	25
LF297/50	52 x 297mm	25
LF240/53	53 x 240mm	25
LF340/60	60 x 343mm	25
LF200/65	65 x 200mm	25
LF235/65	65 x 235mm	25
LF290/65	65 x 290mm	25
LF340/65	65 x 340mm	25
LF235/70	70 x 235mm	25
LF290/70	70 x 290mm	25
LF400/70	70 x 400mm	25
LF235/90	90 x 235mm	25
LF290/90	90 x 290mm	25
LF350/90	90 x 350mm	25
LF220/105	105 x 220mm	10
LF235/120	120 x 235mm	10
LF290/130	130 x 290mm	10
LF235/140	140 x 235mm	10
LF290/140	140 x 290mm	10
LF235/180	184 x 235mm	10
Variable Slope (LF)		
LF224/90VS	90 x 224mm	10
Skewed Left or Right (LF)		
LF275/60SL	60 x 275mm	10
LF275/60SR	60 x 275mm	10
LF215/90SL	90 x 215mm	10
LF215/90SR	90 x 215mm	10
Variable Skew Angle (LF)		
LVSIA	75 x 50 x 5 x 150mm	10

Pryda 40 x3.75mm Galvanised Pryda Timber Connector Nails (included in carton)

No 6 x 30mm Bugle Head or Wafer Head Wood Screws

Note: Refer to I-Joist Hanger Cross Reference Guide in Reference Section Page 31

Note: Screws and nails are not included in the LVSIA carton.

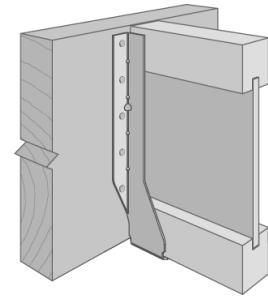

LF I-joist Hangers
- Face Mounted

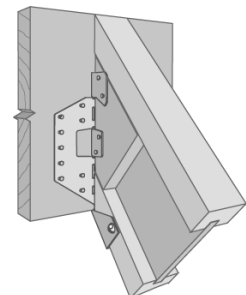

VS I-joist Hangers
-Variable Slope

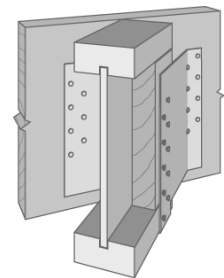

SL = Skewed Left
SR = Skewed Right

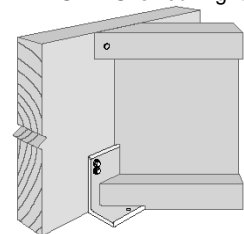

Variable Skew Angle



I-Joist Hangers

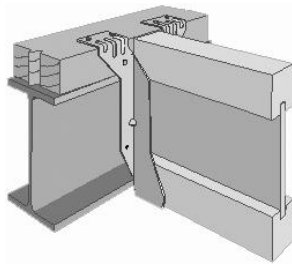

LT = Top Mounted

Product Code	Article & Size	Packed
Top Mounted (LT)		
LT240/40	41 x 240mm	25
LT300/40	41 x 300mm	25
LT300/47	46 x 300mm	25
LT200/50	50 x 200mm	25
LT240/50	50 x 240mm	25
LT240/52	52 x 240mm	25
LT300/52	52 x 300mm	25
LT360/60	60 x 360mm	25
LT240/65	65 x 240mm	25
LT245/65	65 x 245mm	25
LT302/65	65 x 302mm	25
LT360/65	65 x 360mm	25
LT240/70	70 x 240mm	25
LT300/70	70 x 300mm	25
LT240/90	90 x 240mm	25
LT300/90	90 x 300mm	25
LT360/90	90 x 360mm	25
LT400/90	90 x 400mm	25
LT240/105	105 x 240mm	25
LT300/105	105 x 302mm	10
LT240/140	140 x 240mm	10
LT300/140	140 x 300mm	10



Pryda 35x3.75mm Galvanised Pryda Timber Connector Nails (included in carton)

No. 6 x 30mm Bugle Head or Wafer Head Wood Screws

Note Refer to I-Joist Hanger Cross Reference Guide in Reference Section Page 31

Beam Hangers (BB)

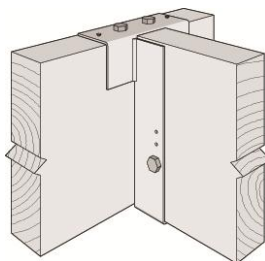

Beam Hanger

Product Code	Article & Size	Packed
Pryda Beam Hangers 3.0mm – Hot Dipped Galvanised		
BB180	186 x 77mm	1
BB300	306 x 77mm	1
BBT125240	240x125mm *	8
BBT180240	240x180mm	1
BBT180300	300x180mm	1
BBT180360	360x180mm	1
Galvanised M10 x 50 mm Coach screws		

*BBT125240 is packed with No.12 x 35mm type 17 hex-head screws.

Hip Support Bracket (TB)

Product Code	Article & Size	Packed
Pryda Support Bracket 3.0mm		
HSB	75 x 68 x 100 x 3mm	50
No. 12 x 35 Type 17 Screw (WTF12-35)		

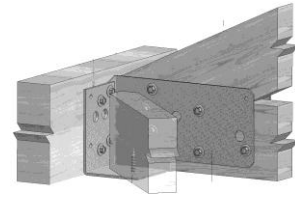

Hip Support Bracket

Joist Boots – Multi-Fix (TB)

Product Code	Article & Size	Packed
Pryda Joist Boots 1.6mm		
TBJ35	125 Flange x 38mm	10
TBJ35/T	125 Flange x 38mm - with tongue	10
TBJ45	125 Flange x 50mm	10
TBJ70	100 Flange x 70mm	10

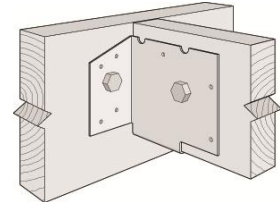

Joist Boot

Note: See table at bottom of page for suggested fasteners

Truss Boots – Multi-Fix (TB)

Product Code	Article & Size	Packed
Pryda Truss Boots 1.6mm		
TB35/12	190 Flange x 38mm- suit M12 bolts/No.12 screws	10
TB35/16	190 Flange x 38mm- suit M16 bolts/No.12 screws	10
TB45/16	190 Flange x 50mm- suit M16 bolts/No.12 screws	10

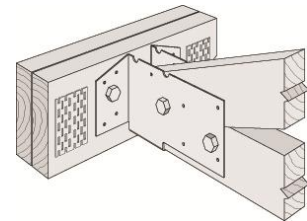

Truss Boot- Multi-Fix

Note: See table at bottom of page for suggested fasteners

Truss Boots – Heavy Duty (TB)

Product Code	Article & Size	Packed
Pryda Heavy Duty Truss Boots 5.0 mm - Hot Dipped Galvanised		
TB80C	275 Flange – suit M16 bolts (central profile)	1
TB80V	275 Flange – suit M16 bolts Hinged	1
Pryda Heavy Duty Truss Boots 4.0 mm - Hot Dipped Galvanised		
TBHD75	275 Flange – suit M16 bolts (central profile)	1
TBHD75/T	Twin Fin - 275 Flanges – suit M16 bolts (central profile)	1

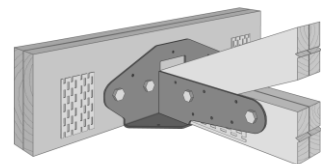
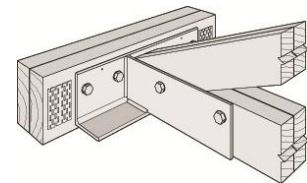

Truss Boot- Heavy Duty

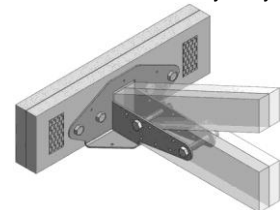

Truss Boot – Twin Fin

Pryda Bolt Kits		
Pryda M12 or M16 Set Screws & Washers		
M12 or M16 Galvanised Bolts, Nuts & Washers		
Pryda 35 x 3.15mm Galvanised Timber Connector Nails		
Pryda Anti-Split Claw Plate – see Hangers & Truss Boots Guide page 18		
No.12 x 35 Type 17 Screw (WTF12-35)		



Knuckle Nailplates (NP)

Product Code	Article & Size	Packed
Pryda Knuckle Nailplates 1.0mm (33mm wide)		
TP4R4	33 mm wide x 127mm	133
TP6R4	33 mm wide x 190mm	89
Pryda Knuckle Nailplates 1.0mm (38mm wide)		
MP4R5	38 mm wide x 127mm	100
MP6R5	38 mm wide x 190mm	66
Pryda Knuckle Nailplates 1.0mm (67mm wide)		
MP4R8	67 mm wide x 127mm	66
MP6R8	67 mm wide x 190mm	44
MP8R8	67 mm wide x 254mm	33
Pryda Knuckle Nailplates 1.0mm (76mm wide)		
MP2R10	76 mm wide x 63mm	100
TP3R10	76 mm wide x 95mm	66
MP4R10	76 mm wide x 127mm	50
MP6R10	76 mm wide x 190mm	33
MP8R10	76 mm wide x 254mm	26
Pryda Knuckle Nailplates 1.0mm (134mm wide)		
MP4R16	134 mm wide x 127mm	33
MP6R16	134 mm wide x 190mm	22
MP8R16	134 mm wide x 254mm	16

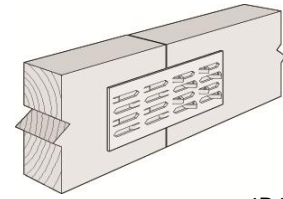

4R4

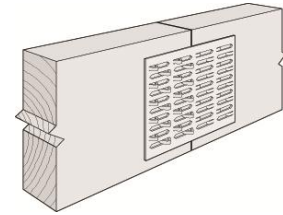

4R10

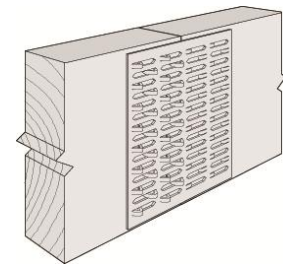

4R16

CODE EXPLANATION

EXAMPLE: MP6R10

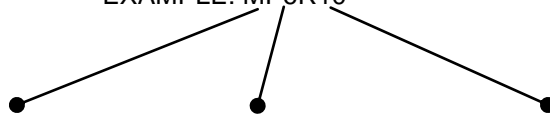

Merchant Pack

No. of rows of Knuckles

No. of Knuckles in a row

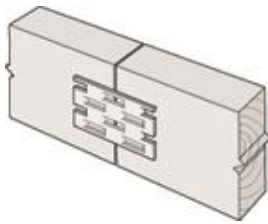

Mininail

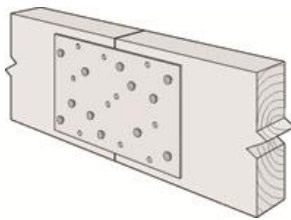

Nail-on Plate

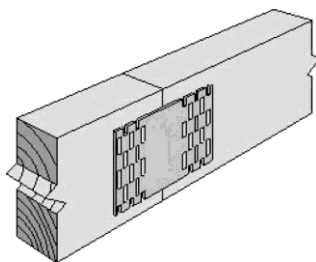

Strap Nail

Mininail (CL)

Product Code	Article & Size	Packed
Pryda Mininail 1.0mm		
2C1S	50 x 25mm	500
Merchant Packs Individually Bar-coded		
MP2C1S	50 x 25mm	7 x 30

Nail-on Plates (AA)

Product Code	Article & Size	Packed
Pryda Nail-on Plates 1.0mm		
NPA75/125	75 x 125mm	60
NPA75/190	75 x 190mm	40
NPA75/250	75 x 250mm	30
NPA75/315	75 x 315mm	25
NPA75/380	75 x 380mm	20
NPA100/190	100 x 190mm	28
NPA150/250	150 x 250mm	15
NPA150/315	150 x 315mm	12
 Pryda 35x3.15 mm Galvanised Pryda Timber Connector Nails		

Strap Nails (SN)

Product Code	Article & Size	Packed
Pryda Strap Nails 1.0mm		
SN5	50 x 100mm	100
Bulk Packs Pryda Strap Nails 1.0mm		
SN5B	50 x 100mm	300
Merchant Packs – Individually Bar-coded		
MPSN2	25 x 100mm Merchant pack	180
MPSN4C	38 x 90mm	75
MPSN5	50 x 100mm Merchant pack	75
MPSN7	75 x 100mm Merchant Pack	50

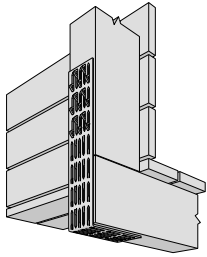

Bin Strap

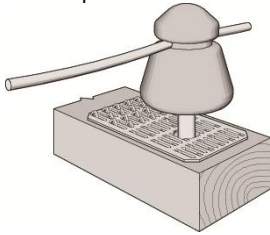

Shunt Plate



Pole Cats

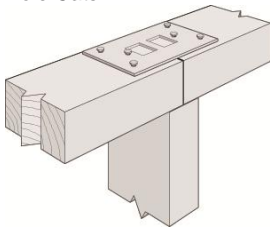

Connector Plate

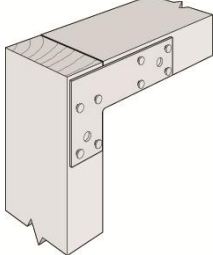

Corner Plate

Bin Straps (NB)

Product Code	Article & Size	Packed
Pryda Bin Straps 1.2mm (NB)		
8N5B1	64 x 190 x 44mm	75

Shunt Plates (N5)

Product Code	Article & Size	Packed
Pryda Shunt Plates 1.2mm (N5)		
5N10	88 x 159mm with hole	80

Pole Cats (PCT)

Product Code	Article & Size	Packed
Pryda Pole Cats		
PCAT150	150mm dia. - with 65mm hole	72
PCAT200	200mm dia. - with 100mm hole	48
PCAT250	250mm dia. - with 75mm hole	36
PCAT300	300mm dia. - with 100mm hole	24

Connector Plate (CP)

Product Code	Article & Size	Packed
Pryda Connector Plate		
CPPQ	110 x 60 x 0.8mm	100
 Pryda 35x3.15 mm Galvanised Pryda Timber Connector Nails		

Corner Plate (CP)

Product Code	Article & Size	Packed
Pryda Corner Plate		
CPL	110 x 60 x 30mm	150
 Pryda 35x3.15 mm Galvanised Pryda Timber Connector Nails		

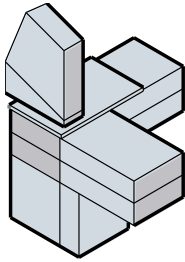

Anti Crush Plate

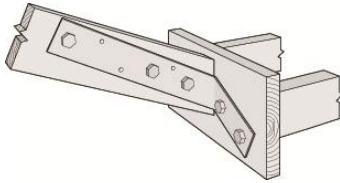

Fascia Support

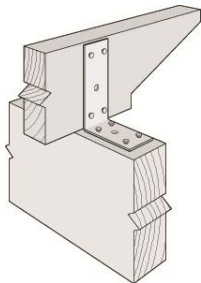

Pergola Angle



Pryda Truss Spacer

Anti-Crush Plate (GMP)

Product Code	Article & Size	Packed
Pryda Anti-Crush Plate 6.0mm		
ACP	140 x 75 mm	5

Fascia Support (UH)

Product Code	Article & Size	Packed
Pryda Fascia Support 2.0mm		
Merchant Packs – Individually Bar-coded		
MPUFB	110 x 300 x 50mm wide Fold at 90° (410mm length overall)	20 (10 Left Hand & 10 Right Hand)
M12 Galvanised Bolts, Nuts & Washers		

Pergola Angles (CPA)

Product Code	Article & Size	Packed
Merchant Packs – Individually Bar-coded		
MPCPA	88 x 63 x 36 x 1.6mm	100
Pryda 35 x 3.15mm Galvanised Timber Connector Nails		

Pryda Truss Spacer (PTS)

Product Code	Article & Size	Packed
Pryda Truss Spacer		
PTS600	Truss Spacer – 600mm	50
PTS900	Truss Spacer – 900mm	20
Pryda 35 x 3.15mm Galvanised Timber Connector Nails		

Universal Heavy Duty Angle (UH)

Product Code	Article & Size	Packed
Merchant Packs – Individually Bar-coded		
MPUHDA	230 x 40 x 40 x 2.0mm	20
No 12 x suitable length Type 17 Screw		

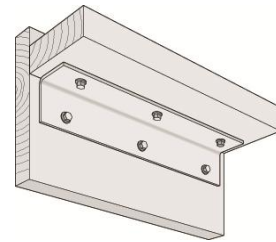

Universal Heavy Duty Angle

Fix – Foil Fix (SF)

Product Code	Article & Size	Packed
Foil Fix (21 x 21mm)		
SFF	50 strips of 10	500

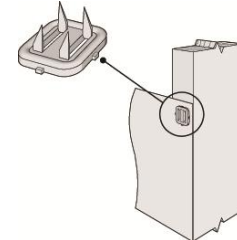

Foil Fix

Fix – Pryda Fix (SF)

Product Code	Article & Size	Packed
Pryda Fix (30 x 30mm)		
SFI	150 Strips of 5 – zinc	750
Merchant Packs – Individually Bar-coded		
MPSFI	Pre-packed 30 x 30 x 0.8mm (7 x 10 strips of 5- zinc)	7 x 50

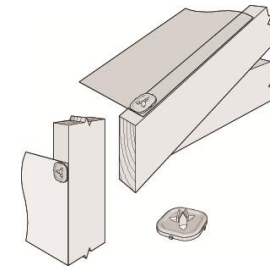

Pryda Fix

Fix – Shade Fix (SF)

Product Code	Article & Size	Packed
Shade Fix (50 x 13mm)		
Merchant Packs – Individually Bar-coded		
MPSFMZ	Pre-pack Shadefix - Zinc	10x 50
MPSFMB	Pre-pack Shadefix - Brown	10 x 50
MPSFMG	Pre-pack Shadefix - Green	10 x 50

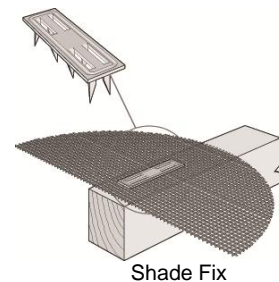

Shade Fix

Barge Angles (GMP)

Product Code	Article & Size	Packed
Pryda Barge Angles		
EBA	External – 50 x 50 x 2400mm	25
IBA	Internal – 120 x 30 x 2400mm	25
75 x 3.75mm Flat Head Nails		

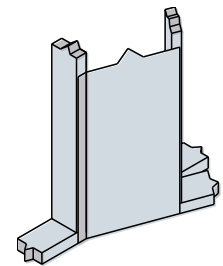

Barge Angle

Hoop Iron & Strapping (GMP)

Product Code	Article & Size	Packed
Pryda Hoop Iron 0.6 x 25mm (GMP)		
Not suitable for structural bracing		
GHP15	0.6 x 25mm x 15m Punched	5 Coils
GHP30	0.6 x 25mm x 30m Punched	1 Coil
Pryda Hoop Iron 0.8 x 25mm (SB)		
Not suitable for structural bracing		
SB082/6	25 x 0.8mm x 6m	1 Coil
SB082/15	25 x 0.8mm x 15m	1 Coil
SB082/30	25 x 0.8mm x 30m	1 Coil
Pryda Unpunched Strapping (GMP)		
GUS083/30	0.8 x 30mm x 30m	1 Coil
Pryda 35x3.15mm Galvanised Pryda Timber Connector Nails		



Hoop Iron



Unpunched Strapping

Post Anchors – Individually Bar-coded

Product Code	Article & Size	Packed
--------------	----------------	--------

Pryda Full Stirrup Post Anchors Hot Dip Gal – 4mm Steel, 25mm dia stem (PA)

PSFS6590	65 mm leg for 90 mm post	10
PSFS65100	65 mm leg for 100 mm post	10
PSFS13090	130 mm leg for 90 mm post	10
PSFS130100	130 mm leg for 100 mm post	10
PSFS130115	130 mm leg for 115 mm post	10
PSFS130125	130 mm leg for 125 mm post	10
PSFS20090	200 mm leg for 90 mm post	10
PSFS200100	200 mm leg for 100 mm post	10
PSFS30090	300 mm leg for 90 mm post	10
PSFS300100	300 mm leg for 100 mm post	10
PSFS300115	300 mm leg for 115 mm post	10
PSFS300125	300 mm leg for 125 mm post	10
PSFS45090	450 mm leg for 90 mm post	10
PSFS450100	450 mm leg for 100 mm post	10
PSFS450115	450 mm leg for 115 mm post	10
PSFS450125	450 mm leg for 125 mm post	10
PSFS60090	600 mm leg for 90 mm post	10
PSFS600100	600 mm leg for 100 mm post	10

Pryda Half Stirrup Post (PA)

PSHS65	65 mm leg Half Stirrup	10
PSHS130	130 mm leg Half Stirrup	10
PSHS200	200 mm leg Half Stirrup	10
PSHS300	300 mm leg Half Stirrup	10

Pryda Centre Fix Post Anchors (PA)

PSCF130	130 mm leg Centre Fix	10
PSCF300	300 mm leg Centre Fix	10

Pryda Centre Pin Post Anchors (PA)

PSCP130	130 mm leg Centre Pin	10
PSCP300	300 mm leg Centre Pin	10

Pryda High Wind Post Anchors Hot Dip Gal – 5 mm Steel (PS)

PSQ30090/12	300 x 50 mm for 90 mm post	6
PSQ300100/12	300 x 50 mm for 100 mm post	6
PSQ45090/12	450 x 50 mm for 90 mm post	6
PSQ450100/12	450 x 50 mm for 100 mm post	6
PSQ60090/12	600 x 50 mm for 90 mm post	6
PSQ600100/12	600 x 50 mm for 100 mm post	6
PSQ600125/12	600 x 50 mm for 125 mm post	6
PSQ600150/12	600 x 50 mm for 150 mm post	6

Pryda Adjustable Post Anchors Hot Dip Gal – 4 mm Steel (PS)

PS85	85 mm leg length	10
PS160	160 mm leg length	10

Pryda Bolt Down Post Anchors 2mm Stirrup / 3mm Base (PS)

PSB90G	Hot Dip Gal for 90mm post	12
PSB100G	Hot Dip Gal for 100mm post	12
PSB115G	Hot Dip Gal for 115mm post	12
PSB125G	Hot Dip Gal for 125mm post	12

M10 & M12 Galvanised Bolts, Nuts & Washers



Full Stirrup Post Anchors



Half Stirrup Post Anchors

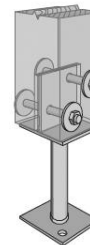

Centre Fix Post Anchors

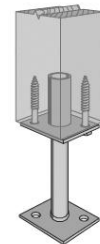

Centre Pin Post Anchors

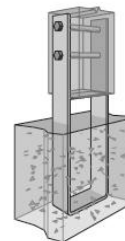

High Wind Post Anchors



Adjustable Post Anchors



Bolt Down Post Anchors

Timber Connector Nails (OSN)

Product Code	Article & Size	Cartons per outer	Packed
Pryda Timber Connector Nails 35 x 3.15mm Approx. 180 Nails per 500g Carton			
OSNGB	Galvanised 500g per pkt	10 cardboard pks per carton	5kg
OSNGC/S	Galvanised 500g per pkt	5 clamshell pkts	2.5kg
OSNG	Galvanised 1kg per pkt	10 cardboard pks per carton	10kg
TPOSNG	Galvanised 5kg Trade Pk	1 Easy Seal carton	5kg
OSNG15	Galvanised 15kg per crtn	1 cardboard Carton	15kg
Pryda Timber Connector Nails 35 x 3.75mm for Top Mount I-Joist Hangers Approx. 140 Nails per 500g Carton			
OSNIB35/S	Galvanised 500g x 10pkts	10 cardboard pks per carton	5kg
Pryda Timber Connector Nails 40 x 3.75mm for Face Mount I-Joist Hangers Approx. 125 Nails per 500g Carton			
OSNIB/S	Galvanised 500g x 10pkts	10 cardboard pks per carton	5kg

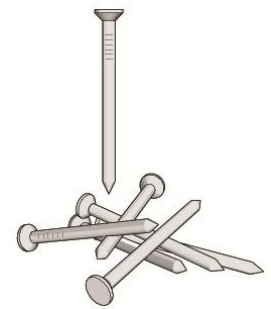

Timber Connector Nails – Galvanised

Ramset DynaBolts® (RDCA)

Product Code	Article & Size	Packed
Dynabolts – Zinc Plated		
DP12100	12 x 98mm	20



Ramset Dynabolt

Ramset AnkaScrews® (AS)

Product Code	Article & Size	Packed
AnkaScrews – Zinc Plated		
AS12100	M12 x 100mm	50

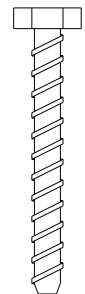

Ramset AnkaScrew



Screwshank Nail

Collated Coil Nails (WCCN)

Product Code	Article & Size	Packed
Collated Coil Nails		
D40810	32 x 2.3mm Duo Fast Screw Hardened Electro Gal, Plastic Collated, Diamond Point	3,600
B25110	32 x 2.5mm Paslode Screw Hardened, Electro, Galv Plastic, Diamond Point	3,600
B25140	50 x 2.0mm Paslode Ring Shank HDG Diamond Point	1,800
B22127	56 x 2.87mm Paslode Screw Shank, Wire Weld Coil Nail, Bright, Diamond Point	6,000
B22154	75 x 3.15mm Paslode Ring Shank, Wire Weld Coil Nail, Bright, Diamond Point	4,500
B22158	75 x 2.87mm Paslode Smooth Shank, Wire Weld Coil Nail, Bright, Diamond Point	4,500
B22070	90 x 3.06mm Paslode Smooth Shank Maxi Coil – 1000 Nails Wire Weld Coil Nail Bright Diamond Point	6,000

Collated Stick Nails (WCSN)

Product Code	Article & Size	Packed
Paper Collated Stick Nails		
B20465	65 x 2.87mm Paslode JDN Strip Nails, Smooth Shank, Bright, Diamond Point	3,000
B20529	65 x 2.87mm Paslode JDN Strip Nails, Smooth Shank, Hot Dip Galvanised, Diamond Point	3,000
B20531	65 x 2.87mm Paslode JDN Strip Nails Ring Shank, Bright, Diamond Point	3,000
B20466D	75 x 3.06mm Paslode JDN Strip Nails, Smooth Shank, Bright – Diamond Point STRIP OF 30 NAILS	3,000
B20467	75 x 3.06mm Paslode JDN Strip Nails, Smooth Shank, Bright – Diamond Point STRIP OF 40 NAILS	3,000
T75305SB	75 x 3.05mm JDN Strip Nails, Smooth Shank, Bright – Diamond Point STRIP OF 40 NAILS	3,000
B20468	75 x 3.06mm Paslode JDN Strip Nails, Smooth Shank, Bright, Shear Point	3,000
B20529D	75 x 3.06mm Paslode JDN Strip Nails, Hot Dip Galvanised, Smooth Shank, Diamond Point	3,000
B20539	75 x 3.06mm Paslode JDN Strip Nails Ring Shank, Bright, Diamond Point	3,000
B20469	90 x 3.15mm Paslode JDN Strip Nails, Smooth Shank, Bright, Diamond Point	3,000
B20470	90 x 3.15mm Paslode JDN Paper collated Strip Nails, Bright, Shear Point	3,000
B20529F	90 x 3.15mm Paslode JDN Strip Nails Hot Dip Galvanised, Smooth Shank, Diamond Point	3,000



Plain Shank Nail

Collated Staples (WCS)

Product Code	Article & Size	Packed
Collated Staples		
A10503	Paslode W5562 16mm Staples, Smooth, Shank, Coated	10,000
A10505	Paslode W5562 19mm Staples, Smooth Shank, Coated	10,000

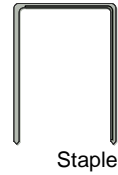

Staple

Corrugated Fasteners (WCF)

Product Code	Article & Size	Packed
Corrugated Fasteners		
A10562	25 x 10mm	5,000

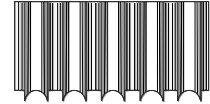

Corrugated Fastener Staple

Paslode Tools (WFST)

Product Code	Article & Size	Packed
Tools		
B20430	PowerMaster PF350-S	1
B21095	Paslode Pneumatic CNW70.2 Coiler Nailer	1
B26100	Positive Placement Nailer F250S	1
D40010	CNP50 Coil Nailer	1
B21100	P350C Coil Nailer	1
D91300	SW1748 Stapler	1
A10555	CF15 Corrugated Fastening Tool	1



PowerMaster 350 Framing Tool



CNP50 Coil Nailer



SW1748 Stapler

Paslode Accessories (WOSS)

Product Code	Article & Size	Packed
Tools		
F27625	Paslode Duo-Fast Lubricating Oil	1



Paslode Lubricating Oil

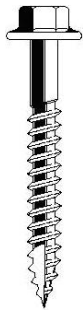

Self Drilling Screw

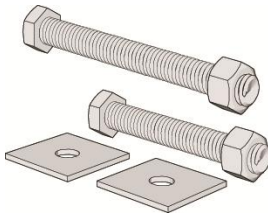

Bolt Kits for Truss Boots

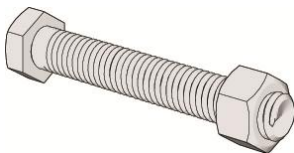

Set Screws

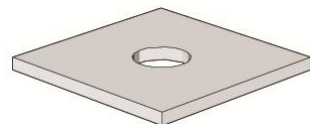

Set Screw Washer

Self Drilling Screws (WSTF)

Product Code	Article & Size	Packed
Self Drilling Screws		
WTF12-35	No12 x35mm Type 17 Hex-head screw	1,000
WTF12-65	No12 x 65mm Type 17 Hex-head screw	1,000

Bolt Kits for Truss Boots (OBK)

Product Code	Article & Size	Packed
Pryda Bolt Kits (for Truss Boots) – Hot Dipped Galvanised		
OBK312	20 kits x 4 M12 Bolts, Nuts & Washers - suit TB35/12, TBS35, TBJ35, TBJ45, TBJ70	80
OBK816	10 kits x 6 M16 Bolts, Nuts & Washers - suit TB80, TBHD75	60

Set Screws (OBS)

Product Code	Article & Size	Packed
Pryda Set Screws – Hot Dipped Galvanised (including Nuts)		
OBS12/65	M12 x 65mm	200
OBS12/100	M12 x 100mm	125
OBS16/110	M16 x 110mm	75

Set Screw Washers (OBS)

Product Code	Article & Size	Packed
Pryda Set Screw Washers – Zinc Plated & Galvanised		
OW12/40S	40 sq x 5mm Galv – suit M12 Ramset AnkaScrews®	50
OW12/56S	56 sq x 3mm Galv – suit M12 bolts or set screws	100
OW16/63S	63 sq x 5mm Galv – suit M16 bolts or set screws	40

Note: These washers are for use where the bolt head or nut bears directly onto timber. They comply with Table 4.12 of AS1720.1 Timber Structures.

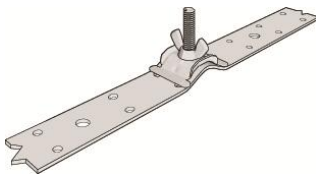

Strap Brace With Tensioner

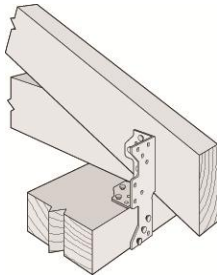

Multigrip

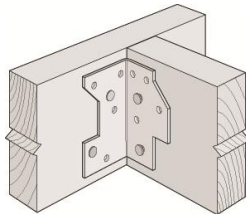

Minigrip

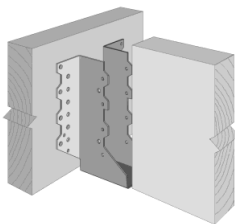

Framing Brackets

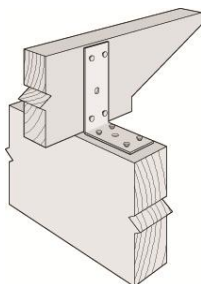

Pergola Angle

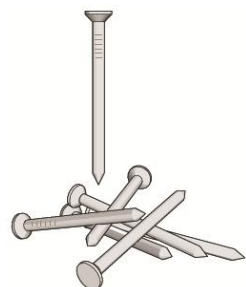

Timber Connector Nails

Strap Brace & Tensioners – Stainless Steel (SS)

Product Code	Article & Size	Packed
Pryda Strap Brace Stainless Steel		
SB102/SS	25 x 1.0mm x 15m	1
Pryda Tensioners Stainless Steel		
SBT/SS	Includes Wing Nut and 'T' bolt	1
Pryda 35x3.15mm Stainless Steel Pryda Timber Connector Nails		

Multigrips – Stainless Steel (SS)

Product Code	Article & Size	Packed
Pryda Multigrips Stainless Steel		
MG/S	100 x 35mm – No Nails	20
Pryda 35x3.15mm Stainless Steel Pryda Timber Connector Nails		

Minigrips – Stainless Steel (SS)

Product Code	Article & Size	Packed
Pryda Minigrips Stainless Steel		
MPMGS/SS	57 x 35mm	20

Framing Brackets – Stainless Steel (SS)

Product Code	Article & Size	Packed
Framing Brackets Stainless Steel		
MPFB3590/SS	35 x 90mm (nominal)	20
MPFB4590/SS	45 x 90mm (nominal)	20
MPFB45120/SS	45 x 120mm (nominal)	20
See page 11 for the Framing Bracket range using Galv. steel		
Pryda 35 x3.15mm Stainless Steel Pryda Timber Connector Nails		

Pergola Angle – Stainless Steel (SS)

Product Code	Article & Size	Packed
Pergola Angle Stainless Steel		
MPCPA/SS	88 x 63 x 36 x 1.6mm	20
Pryda 35 x3.15mm Stainless Steel Pryda Timber Connector Nails		

Timber Connector Nails – Stainless Steel (SS)

Product Code	Article & Size	Packed
Pryda Timber Connector Nails Stainless Steel		
OSNBCI/SS	35 x 3.15mm Flat Head	1 x 500gm

Reference Section

Timber Connector Fixing Guide	29
Fastener Cross Reference Guide	30
Merchant Packs Index	30
I-Joist Hanger Cross Reference Guide	31

Timber Connector Fixing Guide

The size of nail, screw or bolt required for fixing is specified on each Pryda timber connector label. The quantity of nails required for each connector is specified on the Pryda Timber Connector Nail pack label.

Note: Pryda recommends that galvanised protection of all nails, screws and bolts is required to comply with the corrosion protection requirements of the Australian Standard for Residential Timber-Framed Construction AS1684-1999.

Pryda Timber Connector Nails

Pryda Timber Connector Nails must be used with Pryda structural connectors in the quantity specified to ensure the required design strength of the connector is achieved.



Pryda galvanised timber connector nails are specified for most structural connection applications and are available in 3 sizes – 35mm x 3.15, 35mm x 3.75 and 40mm x 3.75.



Pryda stainless steel timber connector nails are required for applications where stainless steel connectors are specified and are available in 1 size – 35mm x 3.15.

Other Fixings (Galvanised)



Flat head nails as required for structural connections where specified.



Bolts are required for structural connections where specified.



Self drilling wood screws are required for structural connections where specified.



Bugle head wood screws are required for structural connections where specified.

Fastener Cross Reference Guide

Pryda Connector	Related Fastener
Beam Hanger	Galvanised M10 x 75 mm coach screws or 75x3.75 mm galvanised flat head nails
Bottom Plate Anchor	Pryda 35 x 3.15mm Galvanised Timber Connector Nails
Bracing	Pryda 35 x 3.15mm Galvanised Timber Connector Nails
Connector Plate, Corner Plate, Cyclone Strap	Pryda 35 x 3.15mm Galvanised Timber Connector Nails
Fascia Support	M12 Bolts, Nuts & Washers
I-Joist Hangers	Pryda 40 x 3.75mm Galvanised Timber Connector Nails No.6 x 30mm Bugle Head or Wafer Head Type 17 Screws No.10 x30mm countersunk, Type 17 screws for LVZIA Angles
Framing Brackets	Pryda 35 x 3.15mm Timber Connector Nails or No.12 x 35 Type 17 Self drilling screws
Joist Hangers - Heavy Duty	Pryda 35 x 3.15mm Galvanised Timber Connector Nails or No.12 x 35 Type 17 Self drilling screws – No.8 x 25 screws for Split Joist Hangers
Joist Strap, Log Support Bracket, Minigrip, Mitre Plates, Multigrip, Nail-On Plates, Pergola Angles	Pryda 35 x 3.15mm Galvanised Timber Connector Nails
Post Anchor - Adjustable	M10 x 50mm Galvanised Coach Screws
Post Anchor - Bolt Down	M10 Galvanised Bolts, Nuts & Washers or M10 x 50mm Galvanised Coach Screw
Post Anchor - Centre Fix	M10 Galvanised Bolts, Nuts & Washers
Post Anchor - Centre Pin	M10 x 75mm Galvanised Coach Screws
Post Anchor - Full Stirrup	M10 Galvanised Bolts, Nuts & Washers or M10 x 40mm Galvanised Coach Screws
Pryda Hitch, Pryda Shear Connector	Pryda 35 x 3.15mm Galvanised Timber Connector Nails
Single Sided Stud Ties	STS3R&L: Paslode Screw Shank Nails (D40810) STS3HR&L: Pryda 35 x 3.15mm Galvanised Timber Connector Nails
Triple Grips	Pryda 35 x 3.15mm Galvanised Timber Connector Nails
Truss Boots & Joist Boots - Multi-Fix	Pryda Bolt Kits or Pryda Set Screws & Washers M12 or M16 Galvanised Bolts, Nuts & Washers Pryda 35 x 3.15mm Galvanised Timber Connector Nails, Pryda Anti-Split Claw Plates, No.12 x 35 Type 17 Screws (WTF12-35)
Truss Boots - Heavy Duty	Pryda Bolt Kits or Pryda Set Screws & Washers or M16 Galvanised Bolts, Nuts & Washers and Pryda Anti-Split Claw Plates
Truss Tie, Unitie	Pryda 35 x 3.15mm Galvanised Timber Connector Nails
Universal Heavy Duty Angle	No.12 Type 17 Screws x suitable length

Merchant Packs Index

Product Description	Page Number
Cyclonic Straps	8
Fascia Supports	20
Framing Brackets	12-13
Knuckle Nailplates	17
Log Support	20
Mininail	18
Multigrips & Minigrips	10
Pergola Angle	20
Pryda Fix	21
Pryda Hitch	10
Pryda Hold Down Bracket	9
Shade Fix	21
Strap Nail	18
Triple Grips	11
Unities	11
Universal Heavy Duty Angle	21

I-Joist Hanger Cross Reference Guide

The recommended size of Pryda I-Joist Hangers for support of proprietary I-joists in house floors is as follows:

I-joist Code	I-joist Size (mm)	Face Mount Hanger Code	Top Mount Hanger Code	Variable Slope & Skew Rafter Hanger Code	Variable Skew Hanger Left Code	Variable Skew Hanger Right Code	Double I-joist Hanger Code Face Mount	Double I-joist Hanger Code Top Mount
Carter Holt Harvey hyJOIST								
HJ200-45	200x45	LF190/45	LT200/50	LF190/47VS*	LVSIA	LVSIA	JHH100*	N/A
HJ240-45	240x45	LF240/45	LT240/50	LF190/47VS*	LVSIA	LVSIA	JHH100*	N/A
HJ300-45	300x45	LF300/45	LT300/47	LF190/47VS*	LVSIA	LVSIA	LF220/105*	N/A
HJ240-63	240x63	LF235/65	LT240/65	LF224/65VS*	LVSIA	LVSIA	N/A	N/A
HJ300-63	300x63	LF290/65	LT302/65	LF224/65VS*	LVSIA	LVSIA	LF290/130	N/A
HJ360-63	360x63	LF340/65	LT360/65	LF224/65VS*	LVSIA	LVSIA	LF290/130*	N/A
HJ240-90	240x90	LF235/90	LT240/90	LF224/90VS*	LF215/90SL*	LF215/90SR*	LF235/180	BBT180240
HJ300-90	300x90	LF290/90	LT300/90	LF224/90VS*	LF215/90SL*	LF215/90SR*	LF235/180*	BBT180300
HJ360-90	360x90	LF350/90	LT360/90	LF224/90VS*	LF215/90SL*	LF215/90SR*	LF235/180*	BBT180360
HJ400-90	400x90	LF350/90	LT400/90	LF224/90VS*	LF215/90SL*	LF215/90SR*	LF235/180*	N/A
Tillings SmartFrame Joist								
SJ24040	240x40	LF235/40	LT240/40	N/A	LVSIA	LVSIA	N/A	N/A
SJ30040	300x40	LF297/40	LT300/40	N/A	LVSIA	LVSIA	N/A	N/A
SJ20044	200x44	LF190/45	LT200/50	LF190/47VS*	LVSIA	LVSIA	LF190/90	NA
SJ24051	240x51	LF235/50	LT240/52	N/A	LVSIA	LVSIA	LF220/105	LT240/105
SJ30051	300x50	LF297/50	LT300/52	N/A	LVSIA	LVSIA	LF220/105*	LT300/105
SJ36058	360x58	LF340/60	LT360/60	LF224/59VS*	LF275/60SL*	LF275/60SR*	LF235/120*	LT356/121
SJ24070	240x70	LF235/70	LT240/70	N/A	LVSIA	LVSIA	LF235/140	LT240/140
SJ30070	300x70	LF290/70	LT300/70	N/A	LVSIA	LVSIA	LF290/140	LT300/140
SJ24090	240x90	LF235/90	LT240/90	LF224/90VS*	LF215/90SL*	LF215/90SR*	LF235/180	BBT180240
SJ30090	300x90	LF290/90	LT300/90	LF224/90VS*	LF215/90SL*	LF215/90SR*	LF235/180*	BBT180300
SJ36090	360x90	LF350/90	LT360/90*	LF224/90VS*	LF215/90SL*	LF215/90SR*	LF235/180*	BBT180360
SJ40090	400x90	LF350/90*	LT400/90	LF224/90VS*	LF215/90SL*	LF215/90SR*	LF235/180*	NA
Wesbeam e-joist								
EJ20045	200x45	LF190/45	LT200/50	LF190/47VS*	LVSIA	LVSIA	JHH100*	NA
EJ24045	240x45	LF240/45	LT240/50	LF190/47VS*	LVSIA	LVSIA	JHH100*	NA
EJ24545	245x45	LF240/45	LT245/45	LF190/47VS*	LVSIA	LVSIA	JHH100*	NA
EJ24051	240x51	LF235/50	LT240/52	N/A	LVSIA	LVSIA	LF220/105	LT240/105
EJ24090	240x90	LF235/90	LT240/90	LF224/90VS*	LF215/90SL*	LF215/90SR*	LF235/180	BBT180240
EJ30045	300x45	LF300/45	LT300/47	LF190/47VS*	LVSIA	LVSIA	LF220/105*	NA
EJ30051	300x51	LF297/50	LT300/52	N/A	LVSIA	LVSIA	LF220/105*	LT300/105
EJ30090	300x90	LF290/90	LT300/90	LF224/90VS*	LF215/90SL*	LF215/90SR*	BBT180/300	BBT180300
EJ24563	245x63	LF235/63	LT245/65	LF224/65VS*	LVSIA	LVSIA	N/A	N/A
EJ36063	360x63	LF340/65	LT360/65	LF224/65VS*	LVSIA	LVSIA	LF290/130*	N/A
EJ36090	360x90	LF350/90	LT360/90	LF224/90VS*	LF215/90SL*	LF215/90SR*	LF235/180*	BBT180360
EJ40090	400x90	LF350/90 *	LT400/90	LF224/90VS*	LF215/90SL*	LF215/90SR*	LF235/180*	N/A
LP I Joist								
LPI 225x53	225x53	LF225/53	N/A	N/A	LVSIA	LVSIA	N/A	N/A
LPI 241x53	241x53	LF240/53	LT240/52	N/A	LVSIA	LVSIA	N/A	N/A
LPI 302x53	302x53	LF300/53	LT300/52	N/A	LVSIA	LVSIA	N/A	N/A
LPI 225x70	225x70	LF225/70	N/A	N/A	LVSIA	LVSIA	N/A	N/A
LPI 241x70	241x70	LF235/70	LT240/70	N/A	LVSIA	LVSIA	LF235/140	LT240/140
LPI 302x70	302x70	LF290/70	LT300/70	N/A	LVSIA	LVSIA	LF290/140	LT300/140
LPI 356x70	356x70	LF350/70	N/A	N/A	LVSIA	LVSIA	N/A	N/A
LPI 406x70	406x70	LF400/70	N/A	N/A	LVSIA	LVSIA	N/A	N/A

- Notes: 1. For hangers marked *, web stiffeners must be installed in accordance with the I-joist manufacturers' specification.
2. JHH100 are **Heavy Duty Joist Hangers**.

