

The future of **Insulation**

Green Book 2011

The comprehensive guide
for thermal and acoustic
insulation systems.

Revision 2

Fletcher[™]
Insulation

*We safely deliver extraordinary
value to our customers*

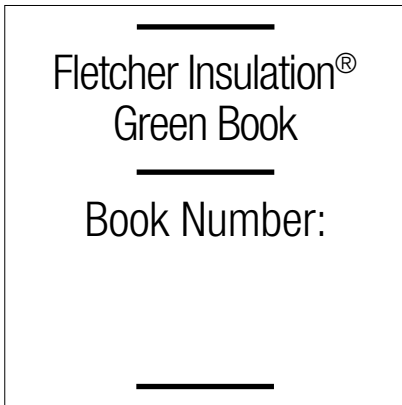

Trademarks

Permastop®, SonoBatts®, Cosyfloor®, Sisalation®, SonoMatt®, TuffStuff®, TitanTuff™, Roof Rack®, InsulMist® are registered trademarks of Fletcher Insulation®. Tyvek™, Homewrap™ are registered trademarks of DuPont®. InsulBubble™ is a registered trademark of Sealed Air®. Pink® and Pink Batts® are a registered trademark of Owens Corning and used under licence by Fletcher Insulation®.

Fletcher Insulation® is a registered trademark of Fletcher Insulation Pty Limited.
© Copyright 2011 Fletcher Insulation Pty Limited ABN 72 001 175 355.

NOTE: Fletcher Insulation Pty. Limited. reserves the right to change product specifications without prior notification. Information in this publication and otherwise supplied to users as to the subject product is based on our general experience and is given in good faith, but because of the many particular factors which are outside our knowledge and control and affect the use of products, no warranty is given or is to be implied with respect to either such information or the product itself, in particular the suitability of the product for any particular purpose. The purchaser should independently determine the suitability of the product for the intended application.

This material is printed on Novatech Satin. Novatech is an environmentally responsible paper produced from FSC (Mixed Sources) CoC certified pulp from Well Managed Forests, is Elemental Chlorine Free (ECF) and is made Carbon Neutral. The greenhouse gas emissions produced from the transport, processing and manufacture of the wood pulp to the delivery to Raleigh Paper's clients (the cradle to gate lifecycle) has been calculated, offset and certified by the Carbon Reduction Institute (CRI). Raleigh Paper has purchased carbon offset credits under the Voluntary Carbon Standard to offset these emissions. Novatech is manufactured by Nordland Papier, a company certified with environmental management systems ISO14001 and EMAS, the EU Eco-Management and Audit Scheme (Reg.No.D-162-00007) Novatech has also been awarded the EU "Flower" eco-label certification.

CONTENTS

FLETCHER INSULATION® BACKGROUND	
Who we are	4
HOW TO USE THE GREEN BOOK	6
GLOSSARY OF TERMS	7
SECTION 1: INTRODUCTION TO THE GREEN BOOK	
The complete guide for energy efficient and acoustic building solutions	10
Products and descriptions	12
Building code of Australia: Classes of buildings	16
Climate zones in Australia	18
Our credentials	20
SECTION 2: RESIDENTIAL ROOFING AND CEILING SYSTEMS	
Residential pitched tiled roof with flat ceiling	24
Residential pitched metal roof with flat ceiling	26
Residential pitched tiled roof with cathedral ceiling (concealed rafters)	28
Residential pitched metal roof with cathedral ceiling (concealed rafters)	30
Residential flat metal roof with plasterboard ceiling (concealed rafters)	32
SECTION 3: RESIDENTIAL WALL SYSTEMS	
Residential brick veneer wall	36
Residential clad timber stud wall (lightweight cladding fixed to battens)	38
Residential clad timber stud wall (steel cladding fixed to battens)	40
Residential clad steel stud wall (lightweight cladding fixed to battens)	42
Residential clad steel stud wall (steel cladding fixed to battens)	44
Residential clad timber stud wall (lightweight cladding fixed direct to stud)	46
Residential cavity clay masonry wall (double brick)	47
Residential reverse brick veneer wall (external cladding fixed directly to stud)	48
Internal timber frame wall 10mm standard plasterboard	50
Internal timber frame wall 10mm acoustic plasterboard	52
Internal steel frame wall 10mm standard plasterboard	54
Internal steel frame wall 10mm acoustic plasterboard	56
SECTION 4: RESIDENTIAL FLOOR SYSTEMS	
Residential suspended timber floor	60
Ceiling under floor (option 1)	61
Ceiling under floor (option 2)	62
Ceiling under floor (fire rated)	63
SECTION 5: COMMERCIAL ROOFING AND CEILING SYSTEMS	
Commercial flat metal roof no ceiling (warehouse)	66
Commercial flat metal roof with suspended ceiling plenum return (ventilated)	67
Commercial flat metal roof with suspended ceiling 100mm – 600mm (non ventilated)	68
Commercial flat metal roof with suspended ceiling 600mm – 1200mm (non ventilated plenum)	70
Commercial concrete roof with no ceiling	72
Commercial concrete suspended slab (car park ceiling below conditioned space)	74
Commercial concrete roof with suspended ceiling 100mm-600mm (non ventilated)	76
Commercial concrete roof with suspended ceiling 600mm-1200mm (non ventilated)	78
SECTION 6: COMMERCIAL WALL SYSTEMS	
Commercial metal clad wall (warehouse purlin girt wall with no internal lining)	82
Commercial metal clad wall with internal lining (warehouse wall with internal lining 100mm – 150mm cavity)	83
Commercial concrete tilt slab (with internal lining)	84

FLETCHER INSULATION® BACKGROUND

WHO WE ARE

We safely deliver extraordinary value to our customers

Fletcher Insulation® has for over 55 years provided energy efficient and acoustic solutions to the residential, commercial and industrial markets. Fletcher Insulation® is the only company in Australia to manufacture and distribute all types of insulation for thermal and acoustic systems.

At the forefront of innovation and development of new trends, cost effective and compliant products, Fletcher Insulation® remains committed to offering valuable service to the architectural and specifier market. Our Technical Services team has the experience and knowledge to provide assistance for any project or development to meet energy efficiency requirements.

OUR MARKETS

COMMERCIAL: The market for insulation in the commercial building sector demands products that enable buildings to meet stringent requirements set out in the Building Code of Australia (BCA) for thermal, acoustic and fire performance. Fletcher Insulation® provides tested and proven insulation products from building blanket for metal deck roofing, *Sisalation* reflective foil insulation for roofing and wall application, air conditioning ductwork or partition wall insulation, to suspended slab and specialist acoustic insulation.

INDUSTRIAL: Fletcher Insulation® manufactures a wide range of specialised products to cater for the insulation needs of industrial applications. Products such as pipe lagging, vessel blanket insulation, foil insulation, rubber pipe insulation and high temperature sheet insulation used for many industrial applications. We also supply customised insulation products used by Original Equipment Manufacturers in the automotive, marine, solar hot water and many other industries. Our products are used to conserve energy, provide a safe environment for workers and attenuate noise.

RESIDENTIAL: Insulation for residential homes, whether supplied during new construction or as a retro-fit, has been the mainstay of our business for many years. The famous *Pink Batts* brand is synonymous with quality home insulation and are used in ceilings, walls and under floors. Thermal insulation comes in a broad range of R-values to suit every climate zone in Australia. More and more acoustic insulation is in demand for modern home design and this market is well catered for with the Fletcher Insulation® acoustic batt range, including high density *Pink SonoBatts* which meets or exceeds the performance of rockwool.

Fletcher Insulation® Branch Network



Fletcher Insulation® has established an Australian wide network of branches to provide efficient customer service throughout the country. A Technical Services Manager is ready in every region to take your inquiry, therefore if you require further assistance please call the Fletcher Insulation® Technical Services Team on 1800 000 878.



HOW TO USE THE GREEN BOOK

STEP 1: Determine which climate zone your project is located in Australia from the map on page 18.

STEP 2: Determine your BCA Building Class, 1-10 from the 'Classes of building' table on page 16.

STEP 3: For roofs incorporating ceiling insulation and exhaust fans, flues or recessed downlights, review the BCA ceiling insulation compensation table (below) for required increase of ceiling insulation R-value.

STEP 4: Determine the design conditions ('Summer' heat flow in or 'Winter' heat flow out) according to the building class, climate zone and state jurisdiction of your project.

STEP 5: Refer to the roof, wall or floor system applicable to your construction type to determine total R-value.

BCA - Ceiling Insulation Compensation

Percentage of ceiling area uninsulated	Minimum R-Value of ceiling insulation required to satisfy 3.12.1.2(a)							
	2.5	3.0	3.5	4.0	4.5	5.0	5.5	6.0
	Adjusted minimum R-Value of ceiling insulation required to compensate for loss of ceiling area insulation							
0.5% to less than 1.0%	2.8	3.4	4.0	4.7	5.4	6.2	6.9	
1.0% to less than 1.5%	2.9	3.6	4.4	5.2	6.1	7.0		
1.5% to less than 2.0%	3.1	3.9	4.8	5.8	6.8			
2.0% to less than 2.5%	3.3	4.2	5.3	6.5				
2.5% to less than 3.0%	3.6	4.6	5.9					

Note: Refer to your insulation supplier for installed weight (kg/m²) of insulation, and your ceiling lining supplier for the allowable dead loads of appliances and insulation

BCA – Design Conditions ('Summer' heat flow in or 'Winter' heat flow out)

		Climate Zone	1	2		3	4	5	6	7	8	
				Below 300m	Above 300m							
BCA 2009	ROOF/WALLS	Class 1&10, 2, 3, 4, 9c	Summer		Winter							
		Class 5,6,7,8,9a,9b	Summer							Winter		
	FLOORS	Class 1&10	Summer		Winter							
		Class 2,3,4,5,6,7,8,9a,9b,9c	Summer				Winter					
BCA 2010	ROOF/WALLS	Class 1&10*	Summer		Winter							
		Class 3, 5, 6, 7, 8, 9*	Summer							Winter		
	FLOORS	Class 1&10*	Summer				Winter					
		Class 3, 5, 6, 7, 8, 9*	Summer				Winter					

Notes: ABCB Design Alert Spec J1.6, Figure 2 shows different values for upwards and downwards but Table J1.6 does not indicate a predominant heat flow direction for each Climate Zone. In the absence of this information, the worst case scenario (or lower R-value in Figure 2 should be used).

Building Classes 2 and 4 must collectively achieve an average energy rating of not less than 6 stars, and individually achieve an energy rating of not less than 5 stars, and comply with **J1.2; J1.3(d) and J1.5(c), J1.3(c)** for compensating for a loss of ceiling insulation, and **J1.6(c) and J1.6(d)** for floor edge insulation.

GLOSSARY OF TERMS

Added R-value	Thermal resistance added to a construction element by insulation.
Bulk insulation	Insulation depending for its performance upon thickness and thermal conductivity to achieve Material R-value.
Climate Zone	An area defined in the BCA Climate Zone Map of Australia having energy efficiency provisions based on a range of similar climate characteristics.
Conduction	Heat flow transfer by exciting molecules of a solid material.
Convection	Heat flow transferred by movement of a fluid (eg. air movement).
Double Sided	Reflective foil on both faces of reflective insulation.
Double Sided Antiglare	Reflective foil on both faces of reflective insulation with additional ink coating on external face (for OH&S antiglare requirements).
Emittance	Ratio of radiant energy emitted by a surface compared to that of a blackbody (a blackbody emits radiant energy at the maximum rate possible).
FBS-1™ Glass Wool	Insulation composed of bio-soluble glass fibres.
FBS-1™ Mineral Wool	Insulation composed of fibres manufactured from glass or rock.
FBS-1™ Rock Wool	Insulation composed of bio-soluble rock fibres.
Heat Transfer	Heat flow from a hot to a cold body (see convection, conduction and radiation).
Indoor air film	A layer of air adjacent to the internal surface of the building element.
Material R-value	Thermal resistance determined by dividing thickness by thermal conductivity, excluding surface air film resistances. NOTE: Material R-values shown in the applications may be higher or lower than that stated on packaging. Labelled Material R-values are determined in accordance with AS/NZS 4859.1 - Amdt. 1-2006. The contribution of any insulation product may vary due to the composition of the application. It is for this reason that the Material R-values may vary from their normal values.
Nat. Ventilation	An air space bounded by one or more permeable surfaces allowing a degree of air movement (eg. an attic space below an unsarked tiled roof), 'Natural Ventilation'.
Non-Ventilated	Air space enclosed by non permeable building materials.
Outdoor air film	A layer of air adjacent to the external surface of the building element.
Radiation	Heat flow transfer by electromagnetic radiation (infra red waves).
Reflective Attic Space	Air space between flat ceiling and pitched roof bounded by reflective insulation under roofing material.
Reflective Insulation	Insulation depending for its performance upon reduction of radiant heat transfer across air spaces by use of one or more surfaces of high reflectance and low emittance.
Rw	Weighted sound reduction index. A single number rating of the sound insulation performance of a specific building element.
Single Sided	Reflective foil on only one face of reflective insulation.
Summer	Denotes BCA design heat flow direction INTO the structure.
System R-value	Thermal resistance of a system, or construction of different materials, excluding surface air film resistances.
Thermal bridging	Structural connections that allows heat loss or heat gain through the path of the structural member via conduction.
Thermal conductivity	A measure of the ability of a material to conduct heat.
Total R-value	Thermal resistance associated with a material or system, including surface air film resistances.
Ventilated	Air space ventilation provided by an opening designed to allow air movement, or by mechanical means.
Winter	Denotes BCA design heat flow direction OUT of the structure.

NOTE: The following building material minimum surface mass properties have been assumed in determining the overall weighted sound reduction performance predictions within this handbook:

- 10mm standard plasterboard: 6.9 kg/m²
- 16mm fire rated plasterboard: 12.8 kg/m²
- 110mm brickwork: 176 kg/m²
- 6mm lightweight cladding (e.g. CSR Cemintel 6mm): 9.7 kg/m²
- 8mm compressed fibre cement sheet: 13 kg/m²
- 19mm T&G timber floor / particleboard: 12.1 kg/m²
- 150mm concrete slab: 351 kg/m²

This page is left blank intentionally

Section 1: Introduction to the Green Book

The complete guide for energy efficient and acoustic building solutions. Pg 10

Products and descriptions. Pg 12

Australian building code of Australia classes of building. Pg 16

Climate zones in Australia. Pg 18

Our credentials. Pg 20

SECTION 1: INTRODUCTION TO THE GREEN BOOK

THE COMPLETE GUIDE FOR ENERGY EFFICIENT AND ACOUSTIC BUILDING SOLUTIONS

The Green Book was developed as part of the Fletcher Insulation® Architectural Specifier Folder. An extensive handbook to provide architects and specifiers with simple, energy efficient and cost effective solutions that meet Building Code requirements and comply to all relevant Australian Standards.

With local research and development facilities and a strong team of product developers, Fletcher Insulation® can cater a solution to your specific requirements, for any project or development.

Fletcher Insulation® Technical Services Team: 1800 000 878

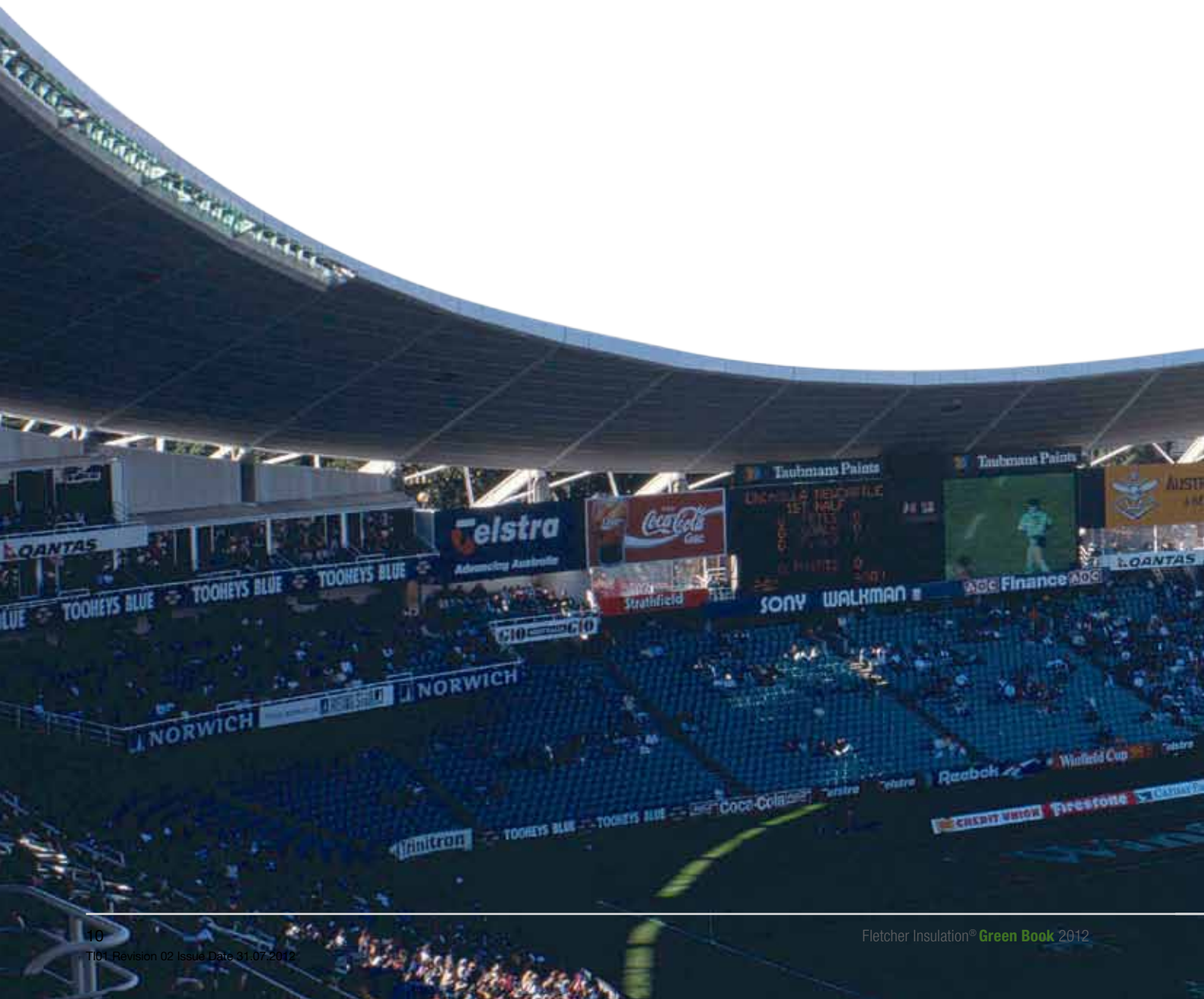



SECTION 1: INTRODUCTION TO THE GREEN BOOK

PRODUCTS AND DESCRIPTIONS

PINK BATTS® CEILING AND WALL INSULATION

R1.5 65mm Pink Wall Batts® R2.0 90mm Pink Wall Batts® R2.0HD 70mm Pink Wall Batts® R2.5HD 90mm Pink Wall Batts® R2.5 Pink Ceiling Batts® R3.0 Pink Ceiling Batts® R3.5 Pink Ceiling Batts® R4.0 Pink Ceiling Batts® R5.0 Pink Ceiling Batts® R6.0 Pink Ceiling Batts®	<p>Pink Batts® are made from lightweight, flexible and resilient glasswool (sometimes referred to as mineral wool), specially designed for the thermal insulation of ceilings and walls in domestic and commercial buildings. They have the added benefit of being an effective sound absorber and thus contribute to both the thermal and acoustic comfort of building occupants.</p> <p>The comprehensive range of sizes and R-values available ensures there is an efficient and effective Fletcher Insulation® Pink Batts® available for any application. Pink Batts® are stiffened to fit snugly between standard spacing wall studs – both timber and steel – without sagging and should be installed at the time of construction prior to fixing internal lining.</p>
--	--

COSYFLOOR® – POLYESTER UNDERFLOOR INSULATION

R1.5 90mm Cosyfloor® R2.0 125mm Cosyfloor®	<p>Cosyfloor® is made from a blend of polyester fibre bonded with a low melt fibre to produce a 100% polyester insulation. Polyester fibres are made from synthetic polymers known as Polyethylene Terephthalate (PET) – chemical substances found mainly in petroleum. Cosyfloor® is designed and pre-cut to fit between standard timber floor joists at 450mm centres. It will also help meet the 6 star energy efficiency requirements for suspended timber floors.</p>
---	--

PINK® SONOBATTS®

R1.3 50mm Pink® SonoBatts® R1.7 70mm Pink® SonoBatts® R2.1 90mm Pink® SonoBatts®	<p>Pink® SonoBatts® are made from lightweight, flexible and resilient glasswool (sometimes referred to as mineral wool), specially designed for quick installation within timber stud framing for commercial and residential buildings. Pink® SonoBatts®, with a nominal density of 14kg/m³ are designed to give assurance of effective sound absorption and reduced noise transfer between rooms. Pink® SonoBatts® is a quality solution to achieving acoustic performance for partition walls between tenancies and bathrooms, as well as adding benefits of enhanced thermal comfort for building occupants.</p>
--	--

PINK® SONOBATTS® PREMIUM

R1.5 50mm Pink® SonoBatts® Premium R2.1 70mm Pink® SonoBatts® Premium R2.7 90mm Pink® SonoBatts® Premium R3.0 100mm Pink® SonoBatts® Premium	<p>Pink® SonoBatts® Premium are the premium range of sound control insulation made from high density, resilient glasswool, sometime referred to as mineral wool. With a nominal density of 32kg/m³ Pink® SonoBatts® Premium are an ideal alternative to Rockwool for timber framed wall cavities, ceiling overlays and between floors for use as sound absorbing materials for home theatres and in architectural acoustic applications such as partitions, screens and baffles. Pink® SonoBatts® Premium are designed to provide optimum performance solutions to 'problem' acoustic applications, particularly when dealing with low frequency sounds. Pink® SonoBatts® Premium also provide excellent thermal performance. The 100mm R3.0 product is an ideal solution for ceilings of homes under flight paths.</p>
---	--

PERMASTOP® BUILDING BLANKET

R1.3 55mm Permastop® Building Blanket R1.8 75mm Permastop® Building Blanket R2.5 100mm Permastop® Building Blanket R3.0 130mm Permastop® Building Blanket R3.5 130mm Permastop® Building Blanket	<p>Permastop® Building Blanket is a high quality insulating product that features excellent thermal and acoustic performance. Permastop® Building Blanket is a glasswool insulation blanket faced on one side with Sisalation reflective foil laminate that is non-permeable to moisture. A 150mm foil lap is provided on one side to allow the moisture barrier to be sealed. Permastop® Building Blanket is able to be supplied with a wide range of Sisalation facings.</p> <p>Permastop® Building Blanket blankets provide condensation control under metal deck roofs, behind wall cladding, and under concrete roof structures to reduce heat loads entering a building. Permastop® Building Blanket also provides an excellent solution for acoustic treatments of metal clad buildings by reducing internal reverberation and unwanted noise created by rain, hail and the expansion and contraction of metal roofing and cladding.</p>
--	---

PINK® BUILDING BLANKET

R1.3 55mm Pink® Building Blanket R1.8 75mm Pink® Building Blanket R2.5 100mm Pink® Building Blanket R3.0 130mm Pink® Building Blanket	<p>Pink® Building Blanket is a lightweight, flexible and resilient glasswool material (sometimes referred to as mineral wool), providing thermal insulation performance with the added benefit of being an effective sound absorption material. These products can be used in conjunction with a Sisalation vapour barrier foil under the blanket where condensation prevention is required. Pink® Building Blanket provides excellent thermal and acoustic insulation when installed under metal deck roofs and in metal clad walls.</p>
--	---

INSULMIST® – THERMAL BREAK INSULATION

InsulMist® 650 (6.5mm) InsulMist® 800 (8mm)	<p>InsulMist® consists of a closed cell polyethylene sheet with double sided reflective foil, one side coated with a highly reflective antiglare coating.</p> <p>InsulMist® can be used in a variety of residential and commercial applications to meet thermal break requirements and to act as a vapour barrier.</p>
--	--

ROOF RACK® – HIGH TENSILE STEEL INSULATION SPACER

Roof Rack® 75mm Spacer Roof Rack® 100mm Spacer	<p>Roof Rack® is a patented insulation spacer which is endorsed by all leading roofing manufacturers for use with concealed fixed and pierce fixed metal deck roofs to allow glasswool insulation blanket to recover to its nominal thickness. Roof Rack® is made from high-tensile Australian steel making it strong and rigid. Roof Rack® creates the space needed for glasswool insulation blanket to recover to its full nominal thickness which is required to achieve a minimum total R3.2 rating as required in Part J of the BCA. Roof Rack® has also been tested for use in cyclonic regions (refer to product datasheet).</p>
---	---

DECK-MATE™ – STYROFOAM INSULATION SPACER

SECTION 1: INTRODUCTION TO THE GREEN BOOK

PRODUCTS AND DESCRIPTIONS

PINK® PARTITION 168 - HIGH DENSITY ACOUSTIC UNDERLAY

Pink® Partition 168 13mm	<p>Pink® Partition 168 is ideal for the control of room to room sound transmission in offices, classrooms, medical rooms, apartments or homes. It provides a barrier against unwanted sound. It is a heavy density glasswool panel that significantly reduces sound transmission when used in timber or steel stud walls. Pink® Partition 168 is typically fixed to partition studs under the plasterboard and thus acts as an isolating medium. Pink® Partition 168 can also be used in concrete floor systems and framed ceilings to create a barrier to sound transmission between floors.</p> <p>Pink® Partition 168 can be used in composite wall and flooring systems to achieve an impact and airborne noise reduction to adjoining areas. Previous testing had shown that Pink® Partition 168, used as a separating medium in floating floor and double leaf wall systems, will elevate the IIC (impact isolation class) performance of the system.</p>
--------------------------	---

PINK® PARTITION 22

R0.7 25mm Pink® Partition 22 R1.0 38mm Pink® Partition 22 R1.4 50mm Pink® Partition 22 R1.8 64mm Pink® Partition 22	<p>Pink® Partition 22 (22kg/m³) deliver excellent thermal and acoustic performance for commercial applications where steel stud construction is used. They are ideal for installation in wall systems. The high performance enables wall systems to easily comply with BCA Part J Total R-value requirements for concrete tilt panel wall construction that is often used for shopping centres, factories and high rise residential buildings.</p>
--	---

INSULBUBBLE™

InsulBubble™ 100 (Antiglare) InsulBubble™ 200 (Non Antiglare)	<p>InsulBubble™ reflective insulation consists of a layer of Polypropylene weave to foil and a layer of PE film to foil both laminated to a fire retardant cell structure. InsulBubble™ 100 is also coated with antiglare ink for protection against sun glare.</p> <p>InsulBubble™ can be used in a variety of residential and commercial applications to increase the thermal performance of the building and to act as a vapour barrier.</p>
--	---

PINK® THERMAL SLAB

R1.5 50mm Pink® Thermal Slab HD Foil Faced R2.3 75mm Pink® Thermal Slab HD Foil Faced R3.0 100mm Pink® Thermal Slab HD Foil Faced R2.3 75mm Pink® Thermal Slab HD White Faced R3.0 100mm Pink® Thermal Slab HD White Faced	<p>Pink® Thermal Slab (32Kg/m³) glasswool sheets provide excellent thermal and acoustic performance, particularly ideal for installation under car park slabs.</p>
--	---

SISALATION®

<p>Sisalation® 466 (Tiled Roof) Super Sisalation® 469 (Tiled Roof)</p>	<p>Sisalation® 466 is a heavy duty single sided poly weave reflective foil laminate recommended for use in the sarking of tiled roofs.</p> <p>This range is flame retardant and suitable for use in buildings in bushfire prone areas to lessen fire hazard by preventing the ingress of sparks into the roof space. It also provides an effective barrier against moisture, vapours, wind, heat and dust penetration when overlapped.</p> <p>Super Sisalation® 469 is a premium fall arrest certified extra heavy duty single sided poly weave reflective foil laminate.</p>
<p>Sisalation® 453 (Metal Roof) Sisalation® 433 (Metal Roof)</p>	<p>Sisalation® 453 (Heavy Duty) and Sisalation® 433 (Medium Duty) are double sided anti-glare reflective foil laminates recommended for use in the sarking of metal roofs. Flame retardant Sisalation® is suitable for use in buildings in bushfire prone areas. Sisalation® 453 and Sisalation® 433 provide an effective barrier against moisture, vapours, wind, heat, and dust penetration.</p>
<p>SisalTuff™ 456 (Multi-Purpose)</p>	<p>Outer layers of aluminium foil bonded to extra heavy duty weave, bonded together with a heavy coating of flame retardant adhesive. The weave face is blue to reduce any problems with reflected glare during installation. SisalTuff™ Multi Purpose is an extra heavy duty foil laminate specifically developed for use in the sarking of residential metal roofs, tiled roofs and as a wall wrap. Flame retardant SisalTuff™ is suitable for use in buildings in bushfire prone areas. When used in conjunction with an airspace it is an effective thermal insulation material because of the high reflectivity and low emissivity of its aluminium foil surface. It also provides an effective barrier against moisture, vapours, wind, heat and dust penetration when overlapped.</p>
<p>Sisalation® 439 (Multi-Purpose)</p>	<p>A single sided anti-glare reflective foil laminate that can be used under suspended timber joists, to wrap brick veneer wall frames, and also under metal deck roofing. Flame retardant Sisalation® 439 is suitable for use in buildings in bushfire prone areas. Sisalation® 439 provides an effective barrier against moisture, vapour, wind, heat and dust penetration when overlapped.</p>
<p>Tuffstuff™ (Wall Wrap)</p>	<p>An extra heavy duty wall wrap (comes in standard and breather) is a single sided poly weave foil recommended for use as a wall wrap behind permeable light weight cladding, such as CFC, for domestic and commercial buildings. Tuffstuff™ is a very strong, tear resistant, vapour permeable membrane that prevents the build-up of trapped moisture between cladding and foil when no air gap exists. It also provides an effective barrier against rain, wind and dust penetration during construction when overlapped. Tuffstuff™ is suitable for use in buildings in bushfire prone areas.</p>
<p>Titantuff™ (Wall Wrap)</p>	<p>An economical medium duty wall wrap typically used behind brick veneers walls for domestic and commercial buildings. Titantuff™ is suitable for fire use in buildings in bushfire prone areas. It is a protective membrane that provides resistance to puncturing and tearing. It also provides an effective barrier against moisture, vapours, wind, heat and dust penetration when overlapped.</p>

TYVEK®

<p>Tyvek® (Home Wrap)</p>	<p>Dupont™ Tyvek® HomeWrap® helps protect a home against damaging wind and rain that can penetrate through the exterior cladding the unique woven structure blocks excess water from entering into walls.</p> <p>The breathable structure of this house wrap allows moisture vapour to pass through to help promote drying in wall systems which can aid in preventing the growth of mould and mildew.</p>
---------------------------	--

SECTION 1: INTRODUCTION TO THE GREEN BOOK

BUILDING CODE OF AUSTRALIA: CLASSES OF BUILDINGS

BCA 2010: The objective is to reduce greenhouse gas emissions. A building must have, to the degree necessary, a level of thermal performance to facilitate the efficient use of energy for artificial heating and cooling. Thermal insulation must comply with AS/NZS 4859.1: 2002 including Amendment 1: 2006.









Class 1	Class 1A	A single dwelling being a detached house or one or more attached dwellings.
	Class 1B	Boarding/guest house or hostel not exceeding 300m ² and not more than 12 people reside.
	Which is not located above or below another dwelling or another Class of building other than a private garage.	
Class 2	A Building containing 2 or more sole occupancy units each being a separate dwelling.	
Class 3	A resident building, other than a class 1 or 2, which is common place of long term or transient living for a number of unrelated persons.	
Class 4	A dwelling in a building that is Class 5, 6, 7, 8 or 9 if it is the only dwelling in the building.	
Class 5	An office building used for professional or commercial purposes, excluding buildings of Class 6, 7, 8 or 9.	
Class 6	A shop or other building for the sale of goods by retail or the supply of services direct to the public.	
Class 7	A building which	
	Class 7A	Is a carpark
	Class 7A	Is for storage or display of goods or produce for sale by wholesale
Class 8	A laboratory, or a building in which a handicraft or process for the production, assembling, altering, repairing, packing, finishing, or cleaning of goods or produce is carried on for trade, sale or gain.	
Class 9	A building of a public nature.	
	Class 9A	A health care building.
	Class 9B	An assembly building in a primary or secondary school, but excluding any other parts of the building that are of another class.
	Class 9C	An aged care building
Class 10	A non habitable building or structure.	
	Class 10A	A private garage, carport, shed or the like.
	Class 10B	A structure being a fence, mast, antenna, retaining or free standing wall, swimming pool or the like.



CLIMATE ZONES IN AUSTRALIA



LEGEND: CLIMATE ZONES

	Zone 1		Zone 5
	Zone 2		Zone 6
	Zone 3		Zone 7
	Zone 4		Zone 8



Building Australia's Future

www.abcb.gov.au

Developed from a map produced by the Bureau of Meteorology.

SECTION 1: INTRODUCTION TO THE GREEN BOOK

OUR CREDENTIALS



FLI-2007
GECA 33-2007-
BUILDING INSULATION

Fletcher Insulation® is Australia's first insulation company to be GECA certified for its glasswool batts and unfaced blanket range of products. This independent accreditation system recognises the development and manufacturing of products that have proven environmental performance and is recognised worldwide through its affiliations.



Global-Mark ISO 9001 certification confirms our Quality Management Systems and instills confidence that Fletcher Insulation® is a proven, compliant company that adheres to the standards designed to provide a framework that will assist in identifying hazards/issues/processes, quantify the risks and put in place control methods to eliminate, reduce or control these risks.



Fletcher Insulation® has received third party product certification to AS/NZS 4859.1. Materials for the thermal insulation of buildings from Global-Mark for most of the glasswool insulation products used in residential and commercial buildings.



The production of environmentally sustainable FBS-1 Glasswool Bio-soluble Insulation® utilises approximately 80% recycled glass. We also use recycled paper in the production of our Sisalation products.



Fletcher Insulation® glasswool products are manufactured from FBS-1 Glasswool Bio-soluble Insulation®. FBS-1 Glasswool Bio-soluble Insulation® is safe to use and meets the criteria of the Australian Safety and Compensation Council (formerly NOHSC) to be classified as not hazardous. Fletcher Insulation® glasswool can be used with confidence in any residential, commercial or industrial application.



BCA Compliant - The Building Code of Australia (BCA) requires that all insulation used to comply with the energy efficiency provisions complies with Australian/New Zealand standard AS/NZS 4859.1. Other requirements for insulation products in the BCA, depending on the application, include compliance with fire standards AS1530.1, AS1530.2, AS1530.3 or UL181 - where Fletcher Insulation® products display the "BCA Compliant" logo they can be trusted to meet the necessary requirements.

This page is left blank intentionally

Section 2: Residential roofing and ceiling systems

Residential pitched tiled roof with flat ceiling. Pg 24

Residential pitched metal roof with flat ceiling. Pg 26

Residential pitched tiled roof with cathedral ceiling (concealed rafters). Pg 28

Residential pitched metal roof with cathedral ceiling (concealed rafters). Pg 30

Residential flat metal roof with plasterboard ceiling (concealed rafters). Pg 32

SECTION 2: RESIDENTIAL ROOFING AND CEILING SYSTEMS

RESIDENTIAL PITCHED TILED ROOF WITH FLAT CEILING

STRUCTURE

Concrete or Terracotta tiled roof between 18° and 35° roof pitch, 40mm battens, reflective foil insulation, reflective attic space, 10mm plasterboard flat ceiling.

INSULATION INSTALLATION

Reflective insulation shall be draped under 40mm battens, antiglare side facing outwards. When used as sarking, reflective insulation foil shall have 150mm overlap in accordance with AS/NZS4200.2: 1994.

To maintain effectiveness as insulation or sarking, any tears or gaps shall be repaired with a suitable reflective foil tape.

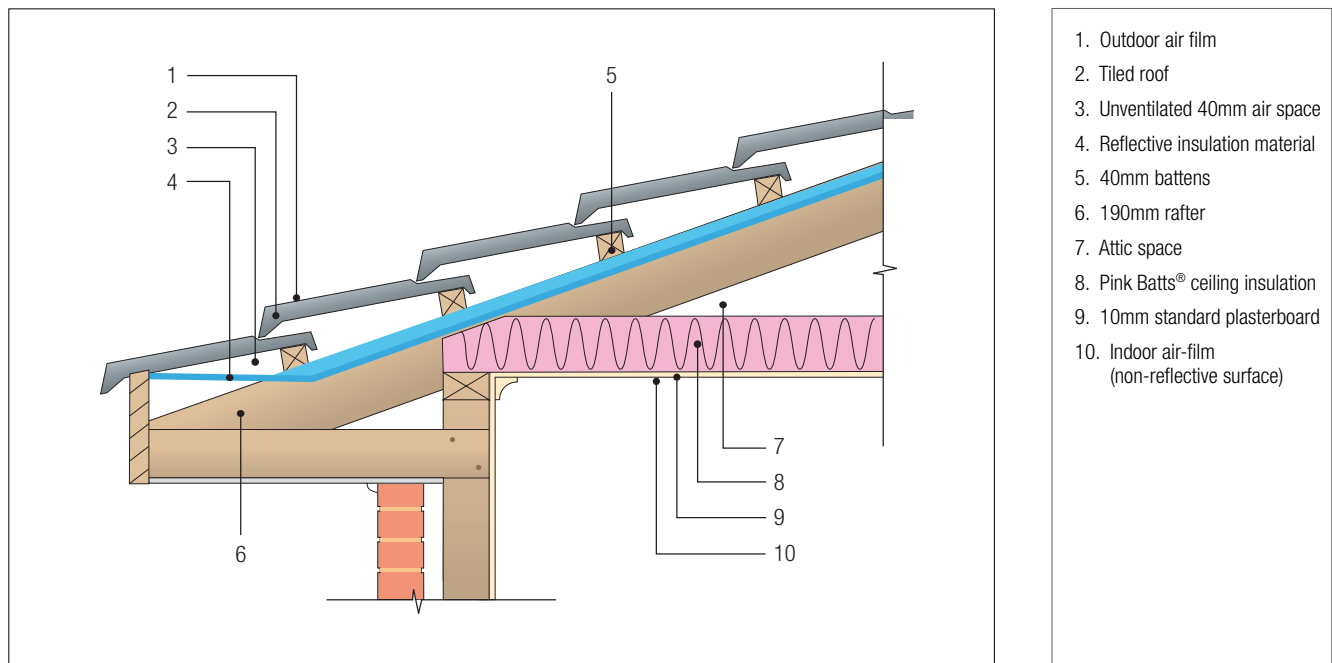

CAD illustrations: www.insulation.com.au/greenbook

CLIMATE ZONES 1-7	PRODUCT VARIATIONS	TOTAL SYSTEM R-VALUES		SOUND REDUCTION INDEX (Rw)	SYSTEM /FEATURE
		WINTER	SUMMER		
Direction of heat flow = Downward (summer) for Climate Zones 1 to 2 (below 300m) Direction of heat flow = Upward (Winter) for Climate Zones 2 (above 300m) to 7 Minimum BCA = R5.1 NOTE: Bushfire prone zones must include roof sarking	NON-VENTILATED				
	Sisalation® 469 with R4.0 Pink Ceiling Batts®	R5.2	R5.4	43	FA
	SisalTuff™ by Sisalation® with R4.0 Pink Ceiling Batts®	R5.2	R5.4	43	ME RE BV
	InsulBubble™ 100 with R4.0 Pink Ceiling Batts®	R5.4	R5.7	43	
	InsulMist® 650 with R3.5 Pink Ceiling Batts®	R5.0	R5.3	43	TB
	InsulMist® 800 with R3.5 Pink Ceiling Batts®	R5.0	R5.3	43	TB
	R5.0 Pink Ceiling Batts®	R5.2	R5.2	43	
	VENTILATED				
	Sisalation® 469 with R3.5 Pink Ceiling Batts®	R4.4	R5.2	43	FA
	SisalTuff™ by Sisalation with R3.5 Pink Ceiling Batts®	R4.4	R5.2	43	ME RE BV
	InsulBubble™ 100 with R3.5 Pink Ceiling Batts®	R4.7	R5.5	43	
	InsulMist® 650 with R3.5 Pink Ceiling Batts®	R4.7	R5.6	43	TB
InsulMist® 800 with R3.5 Pink Ceiling Batts®	R4.8	R5.6	43	TB	
R5.0 Pink Ceiling Batts®	R5.4	R5.6	43		

CLIMATE ZONES 8	PRODUCT VARIATIONS	TOTAL SYSTEM R-VALUES		SOUND REDUCTION INDEX (Rw)	SYSTEM /FEATURE
		WINTER	SUMMER		
Direction of heat flow = Upward (Winter) Minimum BCA = R6.3	NON-VENTILATED				
	Sisalation® 469 with R6.0 Pink Ceiling Batts®	R7.3	R7.3	43	FA
	SisalTuff™ by Sisalation with R6.0 Pink Ceiling Batts®	R7.3	R7.3	43	ME RE BV
	InsulBubble™ with R5.0 Pink Ceiling Batts®	R6.5	R6.6	43	
	InsulMist® 650 with R5.0 Pink Ceiling Batts®	R6.5	R6.7	43	TB
	InsulMist® 800 with R5.0 Pink Ceiling Batts®	R6.6	R6.8	43	TB
	R6.0 Pink Ceiling Batts®	R6.5	R6.5	43	
	VENTILATED				
	Sisalation® 469 with R6.0 Pink Ceiling Batts®	R7.1	R7.6	43	FA
	SisalTuff™ by Sisalation with R6.0 Pink Ceiling Batts®	R7.1	R7.6	43	RE BV
	InsulBubble™ 100 with R6.0 Pink Ceiling Batts®	R7.3	R7.9	43	
	InsulMist® 650 with R5.0 Pink Ceiling Batts®	R6.3	R7.0	43	TB
	InsulMist® 800 with R5.0 Pink Ceiling Batts®	R6.4	R7.1	43	TB
	R6.0 Pink Ceiling Batts®	R6.5	R6.5	43	ME

^ Required where steel trusses are used

NOTES

- A: Calculations and assumptions in accordance with AS/NZS4859.1:2002 Including Amendment 1: 2006 on the path of insulation as required by BCA Volume 1. Part J and Volume 2. Section 3:12, 2011.
- B. Temperatures and Parameters are based on Australian climate assumptions. Air temperature difference 12°C (36°C less 24°C) for summer conditions and 6°C difference (18°C less 12°C) for winter. Actual conditions may differ from standardised conditions. This will impact on the actual performance of the insulation.
- C. Thermal resistance of air films and attic spaces based on values obtained from Section K5 and K6 of AS/NZS 4859.1: 2002 Including Amendment 1: 2006.
- D. Building material elements based on 2000 AIRAH Handbook and attic thermal value based on AS/NZS4859.1: 2002 Including Amendment 1: 2006 App K6 table K2.
- E. Where reflective insulation is installed, a simple addition of R-values is not possible. Care must be taken to ensure the performance of reflective air spaces is not 'double counted'.
- F. The emittance of the reflective surfaces are dependent on tested values and the conditions of the installation, as specified by AS/NZS4859.1: 2002 Including Amendment 1: 2006.
- G. All Residential roofing calculations in this handbook are based on a dark coloured roof. All Commercial roofing calculations in this handbook are based on a light coloured roof. Please refer to the colour absorbance chart for use of coloured roofs. Also refer to roofing material manufacturer's classification of type of colour for their range. Please contact 1800 000 878 for a customised solution.
- H. The Rw estimate tolerance is ± 3dB.

LEGEND:

- ME Most Economical
- RE Recommended
- BV Best Value
- TB Thermal Break
- EE Most Energy Efficient
- RW Best Sound Reduction
- FA Fall Arrest

SECTION 2: RESIDENTIAL ROOFING AND CEILING SYSTEMS

RESIDENTIAL PITCHED METAL ROOF WITH FLAT CEILING

STRUCTURE

Metal roof between 18° and 35° pitch with foil faced blanket product over 40mm battens, reflective insulation, attic space, 10mm plasterboard flat ceiling.

INSULATION INSTALLATION

Foil faced blanket product shall be installed with foil facing attic space with the blanket compressed over battens. Blanket must be allowed to recover to its full nominal thickness. Where Sisalation is used it must be fitter under battens to create a 40mm air space, antiglare side facing outwards. All joins in foil should be lapped 150mm. To maintain the reflective insulation effectiveness, any tears or gaps shall be repaired with a suitable reflective foil tape. Ceiling batts positioned between joists on ceiling lining.

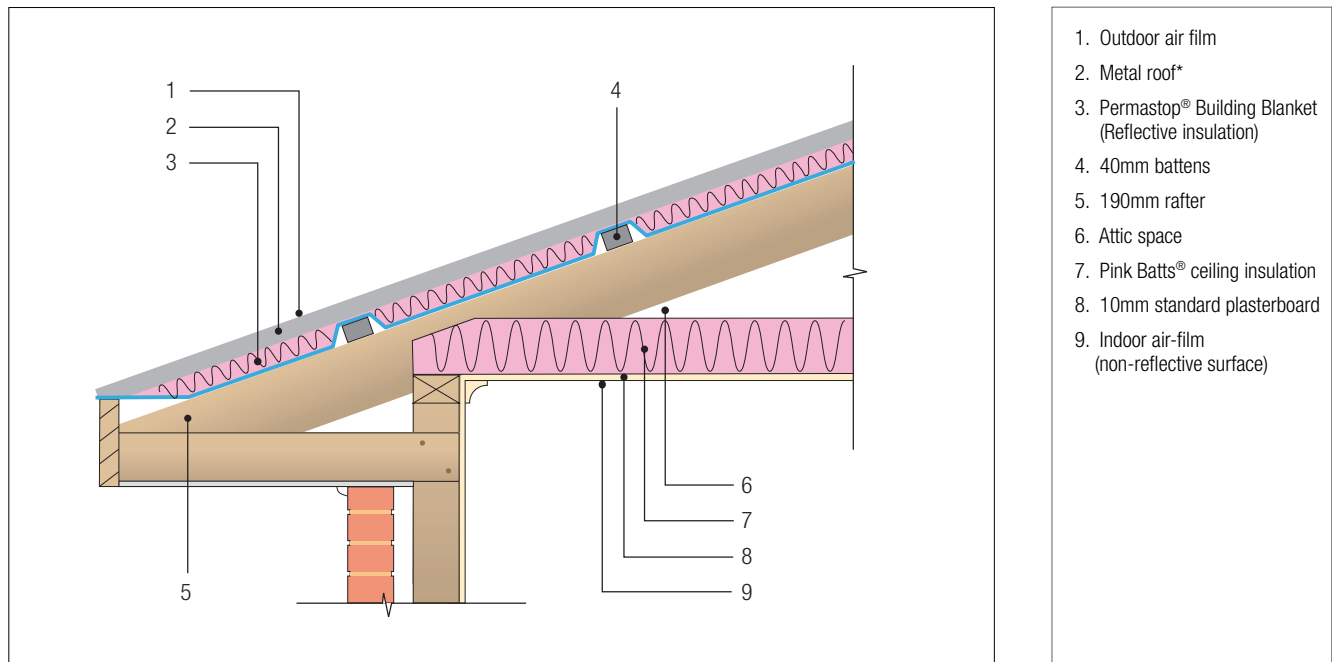

CAD illustrations: www.insulation.com.au/greenbook

CLIMATE ZONES 1-7	PRODUCT VARIATIONS	TOTAL SYSTEM R-VALUES		SOUND REDUCTION INDEX (Rw)	SYSTEM FEATURE
		WINTER	SUMMER		
Direction of heat flow = Downward (Summer) for Climate Zones 1 – 2 (below 300m) Direction of heat flow = Upward (Winter) for Climate Zones 2 (above 300m) – 7 Minimum BCA = R5.1 NOTE: Bushfire prone zones must include roof sarking	NON-VENTILATED				
	Sisalation® 453 with R4.0 Pink Ceiling Batts®	R5.4	R5.7	44	
	SisalTuff® by Sisalation with R4.0 Pink Ceiling Batts®	R5.2	R5.3	44	ME
	R1.3 55mm Permastop® with R3.0 Pink Ceiling Batts®	R5.3	R5.5	44	RE BV TB
	InsulBubble with R4.0 Pink Ceiling Batts®	R5.5	R5.9	44	EE
	InsulMist® 650 with R3.5 Pink Ceiling Batts®	R5.1	R5.5	44	TB
	InsulMist® 800 with R3.5 Pink Ceiling Batts®	R5.1	R5.5	44	TB
	R5.0 Pink Ceiling Batts®	R5.6	R5.3	44	
	VENTILATED				
	Sisalation® 453 with R4.0 Pink Ceiling Batts®	R5.2	R6.0	44	
	SisalTuff® by Sisalation with R4.0 Pink Ceiling Batts®	R4.9	R5.6	44	ME
	R1.3 55mm Permastop® with R2.5 Pink Ceiling Batts®	R4.6	R5.2	44	RE BV TB
	InsulBubble with R4.0 Pink Ceiling Batts®	R5.3	R6.1	44	
	InsulMist® 650 with R4.0 Pink Ceiling Batts®	R5.6	R5.9	44	TB
	InsulMist® 800 with R4.0 Pink Ceiling Batts®	R5.4	R6.3	44	TB EE
	R5.0 Pink Ceiling Batts®	R5.5	R5.5	44	

CLIMATE ZONES 8	PRODUCT VARIATIONS	TOTAL SYSTEM R-VALUES		SOUND REDUCTION INDEX (Rw)	SYSTEM FEATURE
		WINTER	SUMMER		
Direction of heat flow = Upward (Winter) Minimum BCA = R6.3	NON-VENTILATED				
	Sisalation® 453 with R6.0 Pink Ceiling Batts®	R7.5	R7.7	44	EE
	SisalTuff by Sisalation with R6.0 Pink Ceiling Batts®	R7.3	R7.3	44	
	R1.3 55mm Permastop® with R4.0 Pink Ceiling Batts®	R6.3	R6.4	44	ME RE BV TB
	R1.8 75mm Permastop® with R4.0 Pink Ceiling Batts®	R6.9	R6.9	44	TB
	InsulBubble 100 with R5.0 Pink Ceiling Batts®	R6.6	R6.8	44	
	InsulMist® 650 with R5.0 Pink Ceiling Batts®	R6.7	R6.9	44	TB
	InsulMist® 800 with R5.0 Pink Ceiling Batts®	R6.7	R6.9	44	TB EE
	R6.0 Pink Ceiling Batts®	R6.7	R6.3	44	
	VENTILATED				
	Sisalation® 453 with R6.0 Pink Ceiling Batts®	R7.3	R7.9	44	
	SisalTuff by Sisalation with R6.0 Pink Ceiling Batts®	R7.0	R7.5	44	
	R1.3 55mm Permastop® with R5.9 Pink Ceiling Batts®	R6.9	R7.4	44	ME RE BV TB
	R1.8 75mm Permastop® with R5.9 Pink Ceiling Batts®	R7.4	R7.8	44	TB
	InsulBubble 100 with R6.0 Pink Ceiling Batts®	R7.4	R8.0	44	
	InsulMist® 650 with R6.0 Pink Ceiling Batts®	R7.5	R8.1	44	TB
	InsulMist® 800 with R6.0 Pink Ceiling Batts®	R7.5	R8.2	44	TB EE
	R6.0 Pink Ceiling Batts®	R6.5	R6.5	44	

^ Required where steel trusses are used

* Rw calculation based on corrugated 0.48mm BMT metal roof.

NOTES

- A. Calculations and assumptions in accordance with AS/NZS4859.1:2002 Including Amendment 1: 2006 on the path of insulation as required by BCA Volume 1. Part J and Volume 2. Section 3:12, 2011.
- B. Temperatures and Parameters are based on Australian climate assumptions. Air temperature difference 12°C (36°C less 24°C) for summer conditions and 6°C difference (18°C less 12°C) for winter. Actual conditions may differ from standardised conditions. This will impact on the actual performance of the insulation.
- C. Thermal resistance of air films and attic spaces based on values obtained from Section K5 and K6 of AS/NZS 4859.1: 2002 Including Amendment 1: 2006.
- D. Building material elements based on 2000 AIRAH Handbook and attic thermal value based on AS/NZS4859.1: 2002 Including Amendment 1: 2006 App K6 table K2.
- E. Where reflective insulation is installed, a simple addition of R-values is not possible. Care must be taken to ensure the performance of reflective air spaces is not 'double counted'.
- F. The emittance of the reflective surfaces are dependent on tested values and the conditions of the installation, as specified by AS/NZS4859.1: 2002 Including Amendment 1: 2006.
- G. All Residential roofing calculations in this handbook are based on a dark coloured roof. All Commercial roofing calculations in this handbook are based on a light coloured roof. Please refer to the colour absorbance chart for use of coloured roofs. Also refer to roofing material manufacturer's classification of type of colour for their range. Please contact 1800 000 878 for a customised solution.
- H. The Rw estimate tolerance is ± 3dB.

LEGEND:

- Most Economical
- Recommended
- Best Value
- Thermal Break
- Most Energy Efficient
- Best Sound Reduction
- Fall Arrest

SECTION 2: RESIDENTIAL ROOFING AND CEILING SYSTEMS

RESIDENTIAL PITCHED TILED ROOF WITH CATHEDRAL CEILING (CONCEALED RAFTERS)

STRUCTURE

Pitch tiled roof between 18° and 35° pitch, with reflective insulation under 40mm battens with antiglare side facing outwards, 190mm deep rafters below battens with 10mm plasterboard fixed on ceiling battens to rafters.

INSULATION INSTALLATION

Reflective insulation shall be fitted under battens to create a 40mm airspace. All joins should be lapped 150mm in accordance with AS/NZS 4200.2. To maintain effectiveness as insulation any tears or gaps shall be repaired with a suitable reflective foil tape. Where insulation batts (e.g. R4.0) are incorporated in the structure a 25mm reflective airspace is maintained between the lower side of the foil and the batts.

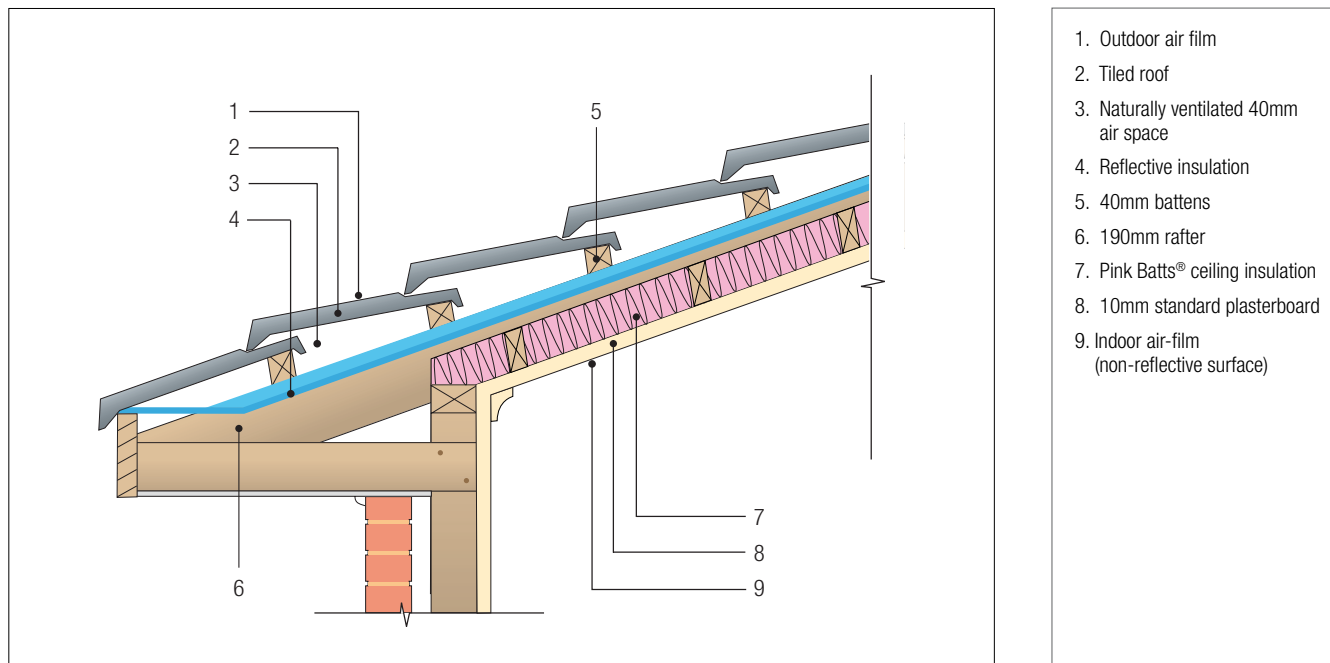

CAD illustrations: www.insulation.com.au/greenbook

SECTION 2: RESIDENTIAL ROOFING AND CEILING SYSTEMS

RESIDENTIAL PITCHED METAL ROOF WITH CATHEDRAL CEILING (CONCEALED RAFTERS)

STRUCTURE

Metal Cathedral roof at 22.5° pitch with foil faced blanket product over 40mm battens with 190mm deep rafters, ceiling insulation, battens with 10mm plasterboard fixed below.

INSULATION INSTALLATION

Foil faced blanket product shall be installed with foil facing attic space with the blanket compressed over battens.

Reflective insulation shall be fitted under battens to create a 40mm airspace. All joins should be lapped 150mm in accordance with AS/NZS 4200.2. To maintain effectiveness as insulation any tears or gaps shall be repaired with a suitable reflective foil tape. Where insulation batts (eg. R4.0) are incorporated in the structure a 25mm reflective airspace is maintained between the lower side of the reflective insulation and the batts.

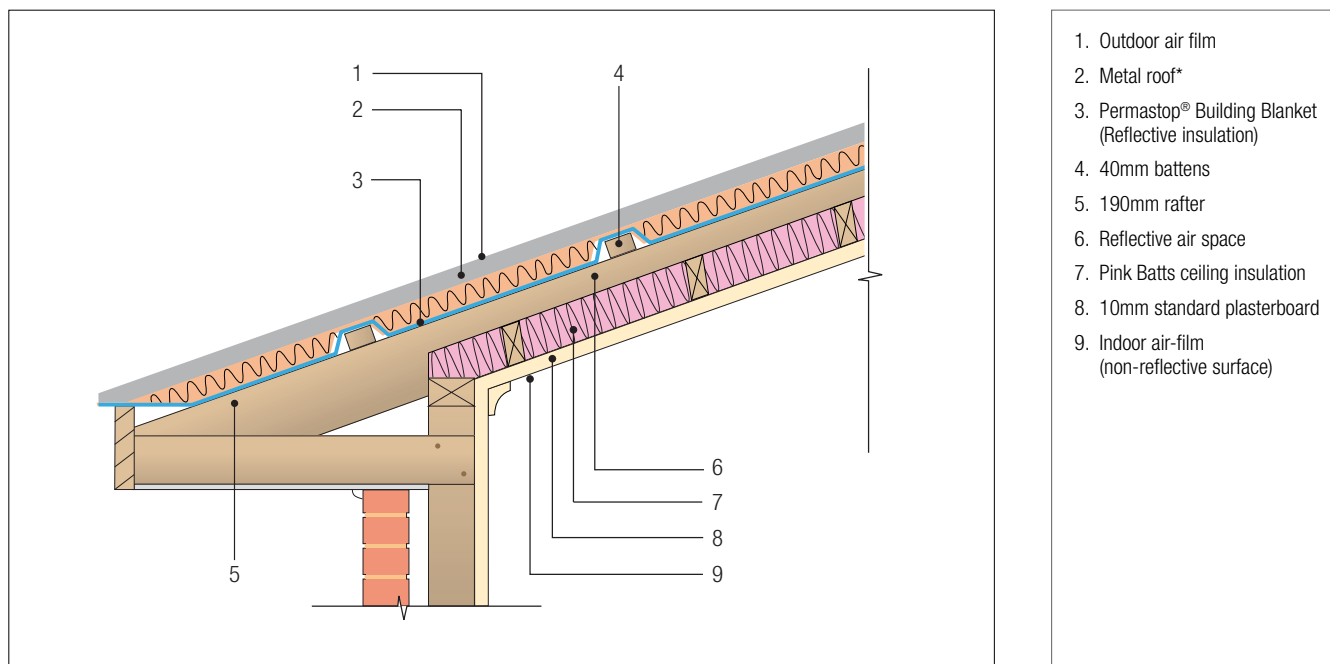

CAD illustrations: www.insulation.com.au/greenbook

SECTION 2: RESIDENTIAL ROOFING AND CEILING SYSTEMS

RESIDENTIAL FLAT METAL ROOF WITH PLASTERBOARD CEILING (CONCEALED RAFTERS)

STRUCTURE

Flat metal roof at 0° to 5° pitch with foil faced blanket product over 40mm battens with ceiling insulation over suspended 10mm plasterboard fixed to ceiling battens.

INSULATION INSTALLATION

Foil faced blanket product shall be installed with foil facing attic space with the blanket compressed over battens. Assume foil faced blanket is sagged but no air space above bulk. Where Sisalation is used it must be fitted under battens to create a 40mm airspace, with foil facing downwards. Assume minimum 25mm air space between foil and top surface of batt. R3.0 Pink Batts® positioned between ceiling battens on plaster ceiling.

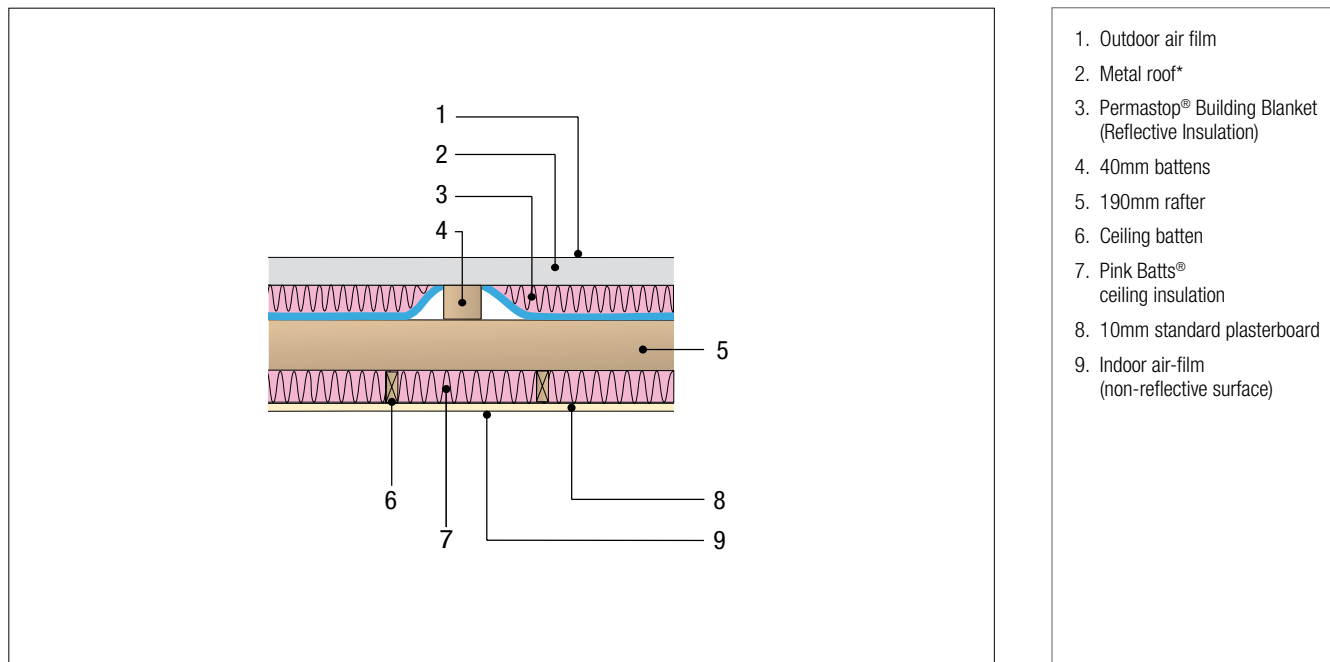

CAD illustrations: www.insulation.com.au/greenbook

This page is left blank intentionally

Section 3: Residential wall systems

Residential brick veneer wall. Pg36

Residential clad timber stud wall
(lightweight cladding fixed to battens).
Pg 38

Residential clad timber stud wall (steel
cladding fixed to battens). Pg 40

Residential clad steel stud wall
(lightweight cladding fixed to battens)
Pg 42

Residential clad steel stud wall (steel
cladding fixed to battens). Pg 44

Residential clad timber stud wall
(lightweight cladding fixed direct to stud)
Pg 46

Residential cavity clay masonry wall
(double brick). Pg 47

Residential reverse brick veneer wall
(external cladding fixed directly to stud)
Pg 48

Internal timber frame wall 10mm
standard plasterboard. Pg 50

Internal timber frame wall 10mm
acoustic plasterboard. Pg 52

Internal steel frame wall 10mm standard
plasterboard. Pg 54

Internal steel frame wall 10mm acoustic
plasterboard. Pg56

SECTION 3: RESIDENTIAL WALL SYSTEMS

RESIDENTIAL BRICK VENEER WALL

STRUCTURE

Brick veneer construction with reflective insulation attached to outside of frame. 110mm General extruded bricks. Non-vented airspace, brick cavity. (Note: Cavity dimension may vary subject to foil product thickness). Bright side of the foil faces the stud cavity. 90mm stud, non vented airspace or bulk insulation installed in cavity with 10mm plasterboard lining.

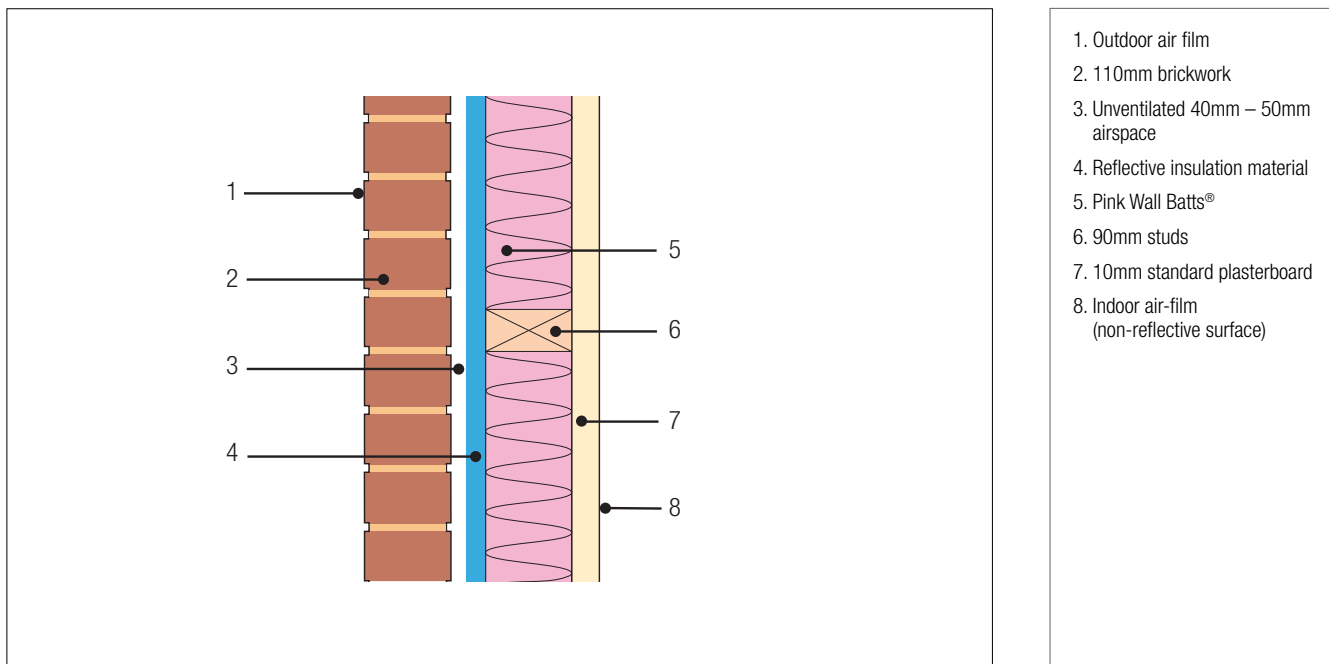

CAD illustrations: www.insulation.com.au/greenbook

CLIMATE ZONES 1-7 Direction of heat flow = Inward (Summer) for Climate Zones 1 to 2 (below 300m) Direction of heat flow = Outward (Winter) for Climate Zones 2 (above 300m) to 7 Minimum BCA = R2.8 * For 70mm studs ** The use of a wall wrap is recommended to maintain moisture and vapour control.	PRODUCT VARIATIONS	TOTAL SYSTEM R-VALUES		SOUND REDUCTION INDEX (Rw)	SYSTEM FEATURE
	NON-VENTILATED	WINTER	SUMMER		
	Titantuff™ Wall Wrap with 90mm R2.5 HD Pink Wall Batts®	R3.2	R3.0	66	ME
	Tuffstuff™ Wall Wrap with 90mm R2.5 HD Pink Wall Batts®	R3.2	R3.0	66	RE BV
	SisalTuff™ by Sisalation® with 90mm R2.5 HD Pink Wall Batts®	R3.2	R3.0	66	
	Sisalation™ 439* with R2.5 HD Pink Wall Batts®	R3.7	R3.4	66	
	InsulBubble® 100 with R2.5HD Pink Wall Batts®	R3.8	R3.5	66	
	InsulMist® 650 with R2.5 HD Pink Wall Batts®	R3.9	R3.6	66	TB
	InsulMist® 800 with R2.0 Pink Wall Batts*	R3.9	R3.6	66	TB EE
	R2.5 HD 90mm Pink Wall Batts®	R3.2	R3.0	66	
	R2.7 90mm Pink® SonoBatts® Premium**	R3.4	R3.1	66	

CLIMATE ZONE 8 Direction of heat flow = Outward (Winter) Minimum BCA = R3.8	PRODUCT VARIATIONS	TOTAL SYSTEM R-VALUES		SOUND REDUCTION INDEX (Rw)	SYSTEM FEATURE
	NON-VENTILATED	WINTER	SUMMER		
	Sisalation® 439 Wall Wrap with R2.7 Pink® SonoBatts® Premium	R3.9	R3.4	66	ME RE BV
	InsulBubble™ 100 with R2.7 90mm Pink® SonoBatts® Premium	R4.0	R3.7	66	TB
	InsulMist® 650 with R2.7 90mm Pink® SonoBatts® Premium	R4.1	R3.8	66	TB EE
	InsulMist® 800 with R2.7 90mm Pink® SonoBatts® Premium	R4.1	R3.8	66	
	InsulMist® 800 with R2.5 HD 90mm Pink Wall Batts®	R3.9	R3.6	66	

^ Required where steel trusses are used

NOTES

- A: Calculations and assumptions in accordance with AS/NZS4859.1:2002 Including Amendment 1: 2006 on the path of insulation as required by BCA Volume 1. Part J and Volume 2. Section 3:12, 2011.
- B. Temperatures and Parameters are based on Australian climate assumptions. Air temperature difference 12°C (36°C less 24°C) for summer conditions and 6°C difference (18°C less 12°C) for winter. Actual conditions may differ from standardised conditions. This will impact on the actual performance of the insulation.
- C. Thermal resistance of air films and attic spaces based on values obtained from Section K5 and K6 of AS/NZS 4859.1: 2002 Including Amendment 1: 2006.
- D. Building material elements based on 2000 AIRAH Handbook and attic thermal value based on AS/NZS4859.1: 2002 Including Amendment 1: 2006 App K6 table K2.
- E. Where reflective insulation is installed, a simple addition of R-values is not possible. Care must be taken to ensure the performance of reflective air spaces is not 'double counted'.
- F. The emittance of the reflective surfaces are dependent on tested values and the conditions of the installation, as specified by AS/NZS4859.1: 2002 Including Amendment 1: 2006.
- G. All Residential roofing calculations in this handbook are based on a dark coloured roof. All Commercial roofing calculations in this handbook are based on a light coloured roof. Please refer to the colour absorbance chart for use of coloured roofs. Also refer to roofing material manufacturer's classification of type of colour for their range. Please contact 1800 000 878 for a customised solution.
- H. The Rw estimate tolerance is ± 3dB.

- LEGEND:
- ME Most Economical
 - RE Recommended
 - BV Best Value
 - TB Thermal Break
 - EE Most Energy Efficient
 - RW Best Sound Reduction
 - FA Fall Arrest

SECTION 3: RESIDENTIAL WALL SYSTEMS

RESIDENTIAL CLAD TIMBER STUD WALL (LIGHTWEIGHT CLADDING FIXED TO BATTENS)

STRUCTURE

Light weight cladding fixed over 35mm batten with reflective foil insulation, bright side of foil facing stud cavity. 90mm timber stud, non vented airspace or Pink Batts® insulation installed in cavity with 10mm plasterboard lining.

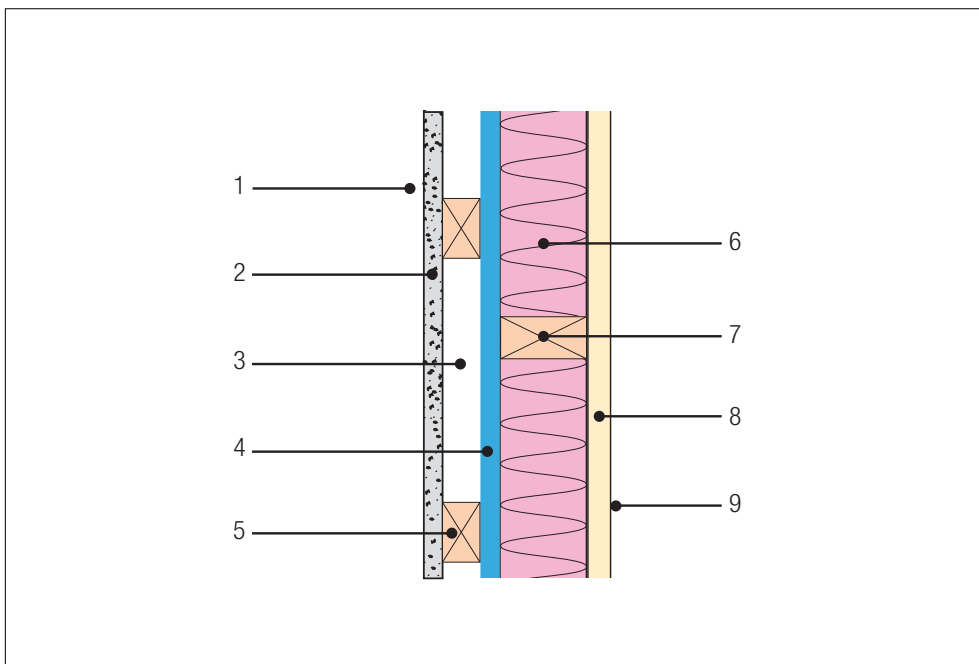

1. Outdoor air film
2. 7.5mm (R0.1) lightweight cladding*
3. Unventilated 35mm airspace
4. Reflective insulation material
5. 35mm battens
6. Pink Wall Batts®
7. 90mm timber stud
8. 10mm standard plasterboard
9. Indoor air-film (non-reflective surface)

CAD illustrations: www.insulation.com.au/greenbook

CLIMATE ZONES 1-7 Direction of heat flow = Inward (Summer) for Climate Zones 1 to 2 (below 300m) Direction of heat flow = Outward (Winter) for Climate Zones 2 (above 300m) to 7 Minimum BCA = R2.8 *for 70mm studs	PRODUCT VARIATIONS	TOTAL SYSTEM R-VALUES		SOUND REDUCTION INDEX (Rw)	SYSTEM FEATURE
	NON-VENTILATED	WINTER	SUMMER		
		Titantuff™ Wall Wrap with R2.7 90mm Pink® SonoBatts® Premium	R3.4	R3.1	43
	Tuffstuff™ Wall Wrap with R2.7 90mm Pink® SonoBatts® Premium	R3.4	R3.1	43	RE BV
	Sisaltuff™ by Sisalation® with R2.7 90mm Pink® SonoBatts® Premium	R3.4	R3.1	43	
	InsulBubble™ 100 with R2.7 90mm Pink® SonoBatts® Premium	R4.0	R3.6	43	
	InsulMist® 650 with R2.7 90mm Pink® SonoBatts® Premium	R4.1	R3.7	43	TB EE
	InsulMist® 800 with R2.5 Pink Wall Batts	R3.9	R3.6	43	TB
	Tyvek™ with R2.5 Pink Wall Batts	R3.2	R2.9	43	
	Sisalation® 439 with R2.1 70mm Pink® SonoBatts® Premium*	R3.4	R3.1	43	

CLIMATE ZONE 8 Direction of heat flow = Outward (Winter) Minimum BCA = R3.8	PRODUCT VARIATIONS	TOTAL SYSTEM R-VALUES		SOUND REDUCTION INDEX (Rw)	SYSTEM FEATURE
	NON-VENTILATED	WINTER	SUMMER		
		Sisalation® 439 with R2.7 90mm Pink® SonoBatts® Premium	R3.9	R3.5	43
	InsulBubble™ 100 with R2.7 90mm Pink® SonoBatts® Premium	R4.0	R3.6	43	TB EE
	InsulMist® 650 with R2.7 90mm Pink® SonoBatts® Premium	R4.1	R3.7	43	
	InsulMist® 800 with R2.7 90mm Pink® SonoBatts® Premium	R4.1	R3.8	43	

^ Required where steel trusses are used

* Rw calculation based on Blueboard 7.5mm lightweight cladding.

NOTES

- A: Calculations and assumptions in accordance with AS/NZS4859.1:2002 Including Amendment 1: 2006 on the path of insulation as required by BCA Volume 1. Part J and Volume 2. Section 3:12, 2011.
- B. Temperatures and Parameters are based on Australian climate assumptions. Air temperature difference 12°C (36°C less 24°C) for summer conditions and 6°C difference (18°C less 12°C) for winter. Actual conditions may differ from standardised conditions. This will impact on the actual performance of the insulation.
- C. Thermal resistance of air films and attic spaces based on values obtained from Section K5 and K6 of AS/NZS 4859.1: 2002 Including Amendment 1: 2006.
- D. Building material elements based on 2000 AIRAH Handbook and attic thermal value based on AS/NZS4859.1: 2002 Including Amendment 1: 2006 App K6 table K2.
- E. Where reflective insulation is installed, a simple addition of R-values is not possible. Care must be taken to ensure the performance of reflective air spaces is not 'double counted'.
- F. The emittance of the reflective surfaces are dependent on tested values and the conditions of the installation, as specified by AS/NZS4859.1: 2002 Including Amendment 1: 2006.
- G. All Residential roofing calculations in this handbook are based on a dark coloured roof. All Commercial roofing calculations in this handbook are based on a light coloured roof. Please refer to the colour absorbance chart for use of coloured roofs. Also refer to roofing material manufacturer's classification of type of colour for their range. Please contact 1800 000 878 for a customised solution.
- H. The Rw estimate tolerance is ± 3dB.

LEGEND:

- ME Most Economical
- RE Recommended
- BV Best Value
- TB Thermal Break
- EE Most Energy Efficient
- RW Best Sound Reduction
- FA Fall Arrest

SECTION 3: RESIDENTIAL WALL SYSTEMS

RESIDENTIAL CLAD TIMBER STUD WALL (STEEL CLADDING FIXED TO BATTENS)

STRUCTURE

Light weight cladding fixed over 35mm batten with reflective foil insulation, bright side of foil facing stud cavity. 90mm timber stud, non vented airspace or Pink Batts® insulation installed in cavity with 10mm plasterboard lining.

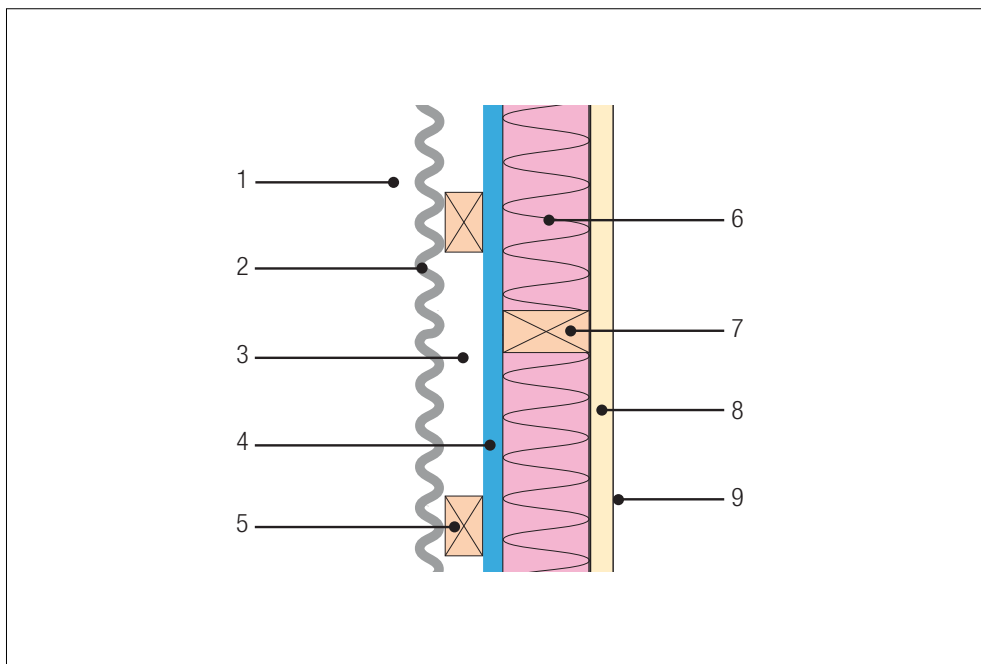

1. Outdoor air film
2. Steel cladding*
3. Unventilated 35mm airspace
4. Reflective insulation material
5. 35mm battens
6. Pink Wall Batts®
7. 90mm timber stud
8. 10mm standard plasterboard
9. Indoor air-film (non-reflective surface)

CAD illustrations: www.insulation.com.au/greenbook

CLIMATE ZONES 1-7 Direction of heat flow = Inward (Summer) for Climate Zones 1 to 2 (below 300m) Direction of heat flow = Outward (Winter) for Climate Zones 2 (above 300m) to 7 Minimum BCA = R2.8 *for 70mm studs	PRODUCT VARIATIONS	TOTAL SYSTEM R-VALUES		SOUND REDUCTION INDEX (Rw)	SYSTEM FEATURE
		WINTER	SUMMER		
	NON-VENTILATED				
	Titantuff™ Wall Wrap with R2.7 90mm Pink® SonoBatts® Premium	R3.3	R3.0	39	ME RE BV
	Tuffstuff™ Wall Wrap with R2.7 90mm Pink® SonoBatts® Premium	R3.3	R3.0	39	EE
	InsulBubble™ 100 with R2.7 90mm Pink® SonoBatts® Premium*	R3.9	R3.5	39	
	InsulMist® 650 with R2.7 Pink® SonoBatts® Premium	R4.0	R3.6	39	
	InsulMist® 800 with R2.5 HD Pink Wall Batts™	R3.8	R3.5	39	
	Tyvek™ with R2.5 HD Pink Wall Batts™	R3.1	R2.8	39	
	Sisalation® 439 with R2.1 70mm Pink® SonoBatts® Premium	R3.1	R2.8	39	

CLIMATE ZONE 8 Direction of heat flow = Outward (Winter) Minimum BCA = R3.8	PRODUCT VARIATIONS	TOTAL SYSTEM R-VALUES		SOUND REDUCTION INDEX (Rw)	SYSTEM FEATURE
		WINTER	SUMMER		
	NON-VENTILATED				
	Sisalation® 439 with R2.7 90mm Pink® SonoBatts® Premium	R3.8	R3.4	39	ME RE BV EE RW FA
	InsulBubble™ 100 with R2.7 90mm Pink® SonoBatts® Premium	R3.8	R3.5	39	
	InsulMist® 650 with R2.7 90mm Pink® SonoBatts® Premium	R3.9	R3.6	39	
	InsulMist® 800 with R2.7 90mm Pink® SonoBatts® Premium	R4.0	R3.7	39	

^ Required where steel trusses are used
* Rw calculation based on corrugated 0.48mm BMT steel cladding.

NOTES

- A: Calculations and assumptions in accordance with AS/NZS4859.1:2002 Including Amendment 1: 2006 on the path of insulation as required by BCA Volume 1. Part J and Volume 2. Section 3:12, 2011.
- B. Temperatures and Parameters are based on Australian climate assumptions. Air temperature difference 12°C (36°C less 24°C) for summer conditions and 6°C difference (18°C less 12°C) for winter. Actual conditions may differ from standardised conditions. This will impact on the actual performance of the insulation.
- C. Thermal resistance of air films and attic spaces based on values obtained from Section K5 and K6 of AS/NZS 4859.1: 2002 Including Amendment 1: 2006.
- D. Building material elements based on 2000 AIRAH Handbook and attic thermal value based on AS/NZS4859.1: 2002 Including Amendment 1: 2006 App K6 table K2.
- E. Where reflective insulation is installed, a simple addition of R-values is not possible. Care must be taken to ensure the performance of reflective air spaces is not 'double counted'.
- F. The emittance of the reflective surfaces are dependent on tested values and the conditions of the installation, as specified by AS/NZS4859.1: 2002 Including Amendment 1: 2006.
- G. All Residential roofing calculations in this handbook are based on a dark coloured roof. All Commercial roofing calculations in this handbook are based on a light coloured roof. Please refer to the colour absorbance chart for use of coloured roofs. Also refer to roofing material manufacturer's classification of type of colour for their range. Please contact 1800 000 878 for a customised solution.
- H. The Rw estimate tolerance is ± 3dB.

LEGEND:

ME	Most Economical
RE	Recommended
BV	Best Value
TB*	Thermal Break
EE	Most Energy Efficient
RW	Best Sound Reduction
FA	Fall Arrest

SECTION 3: RESIDENTIAL WALL SYSTEMS

RESIDENTIAL CLAD STEEL STUD WALL (LIGHTWEIGHT CLADDING FIXED TO BATTENS)

STRUCTURE

Lightweight cladding fixed over 35mm batten with reflective foil insulation, bright side of foil facing stud cavity. 92mm steel stud, non vented airspace or Pink Batts® insulation installed in cavity with 10mm plasterboard lining.

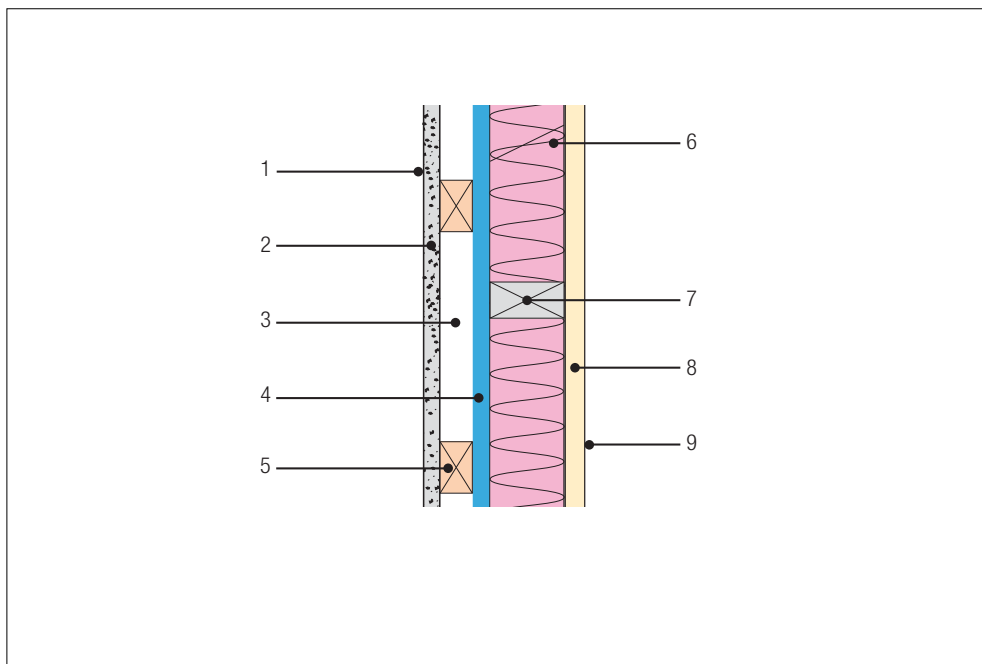

1. Outdoor air film
2. 7.5mm (R0.1) lightweight cladding*
3. Unventilated 35mm airspace
4. Reflective insulation material
5. 35mm battens
6. Pink Wall Batts®
7. 92mm steel stud
8. 10mm standard plasterboard
9. Indoor air-film (non-reflective surface)

CAD illustrations: www.insulation.com.au/greenbook

CLIMATE ZONES 1-7 Direction of heat flow = Inward (Summer) for Climate Zones 1 to 2 (below 300m) Direction of heat flow = Outward (Winter) for Climate Zones 2 (above 300m) to 7 Minimum BCA = R2.8 *for 70mm studs	PRODUCT VARIATIONS	TOTAL SYSTEM R-VALUES		SOUND REDUCTION INDEX (Rw)	SYSTEM FEATURE
		WINTER	SUMMER		
	NON-VENTILATED				
	Titantuff™ Wall Wrap with R2.7 90mm Pink® SonoBatts® Premium	R3.4	R3.1	48	ME
	Tuffstuff™ Wall Wrap with R2.7 90mm Pink® SonoBatts® Premium	R3.4	R3.1	48	RE BV
	SisalTuff™ by Sisalation with R2.7 90mm Pink® SonoBatts® Premium	R3.4	R3.1	48	
	Sisalation® 439 with R2.1 70mm Pink® SonoBatts® Premium*	R3.2	R2.9	48	
	InsulBubble™ 100 with R2.7 90mm Pink® SonoBatts® Premium	R4.0	R3.6	48	BV TB
	InsulMist 650 with R2.7 90mm Pink® SonoBatts® Premium	R4.1	R3.7	48	TB
	InsulMist 800 with R2.5 HD 90mm Pink Wall Batts®	R3.9	R3.6	48	
	Tyvek™ with R2.5 HD 90mm Pink Wall Batts®	R3.2	R2.9	48	

CLIMATE ZONES 8 Direction of heat flow = Outward (Winter) Minimum BCA = R3.8	PRODUCT VARIATIONS	TOTAL SYSTEM R-VALUES		SOUND REDUCTION INDEX (Rw)	SYSTEM FEATURE
		WINTER	SUMMER		
	NON-VENTILATED				
	Sisalation® 439 with R2.7 90mm Pink® SonoBatts® Premium	R3.9	R3.5	48	ME RE BV
	InsulBubble™ 100 with R2.7 90mm Pink® SonoBatts® Premium	R4.0	R3.6	48	TB
	InsulMist® 650 with R2.7 90mm Pink® SonoBatts® Premium	R4.1	R3.7	48	TB EE
	InsulMist® 800 with R2.7 90mm Pink® SonoBatts® Premium	R4.1	R3.8	48	

^ Required where steel trusses are used
* Rw calculation based on Blueboard 7.5mm lightweight cladding.

NOTES

- A: Calculations and assumptions in accordance with AS/NZS4859.1:2002 Including Amendment 1: 2006 on the path of insulation as required by BCA Volume 1. Part J and Volume 2. Section 3:12, 2011.
- B. Temperatures and Parameters are based on Australian climate assumptions. Air temperature difference 12°C (36°C less 24°C) for summer conditions and 6°C difference (18°C less 12°C) for winter. Actual conditions may differ from standardised conditions. This will impact on the actual performance of the insulation.
- C. Thermal resistance of air films and attic spaces based on values obtained from Section K5 and K6 of AS/NZS 4859.1: 2002 Including Amendment 1: 2006.
- D. Building material elements based on 2000 AIRAH Handbook and attic thermal value based on AS/NZS4859.1: 2002 Including Amendment 1: 2006 App K6 table K2.
- E. Where reflective insulation is installed, a simple addition of R-values is not possible. Care must be taken to ensure the performance of reflective air spaces is not 'double counted'.
- F. The emittance of the reflective surfaces are dependent on tested values and the conditions of the installation, as specified by AS/NZS4859.1: 2002 Including Amendment 1: 2006.
- G. All Residential roofing calculations in this handbook are based on a dark coloured roof. All Commercial roofing calculations in this handbook are based on a light coloured roof. Please refer to the colour absorbance chart for use of coloured roofs. Also refer to roofing material manufacturer's classification of type of colour for their range. Please contact 1800 000 878 for a customised solution.
- H. The Rw estimate tolerance is ± 3dB.

LEGEND:

- ME Most Economical
- RE Recommended
- BV Best Value
- TB Thermal Break
- EE Most Energy Efficient
- RW Best Sound Reduction
- FA Fall Arrest

SECTION 3: RESIDENTIAL WALL SYSTEMS

RESIDENTIAL CLAD STEEL STUD WALL (STEEL CLADDING FIXED TO BATTENS)

STRUCTURE

Steel cladding fixed over 35mm batten with reflective foil insulation, bright side of foil facing stud cavity. 92mm steel stud, non vented airspace or Pink Batts® insulation installed in cavity with 10mm plasterboard lining.

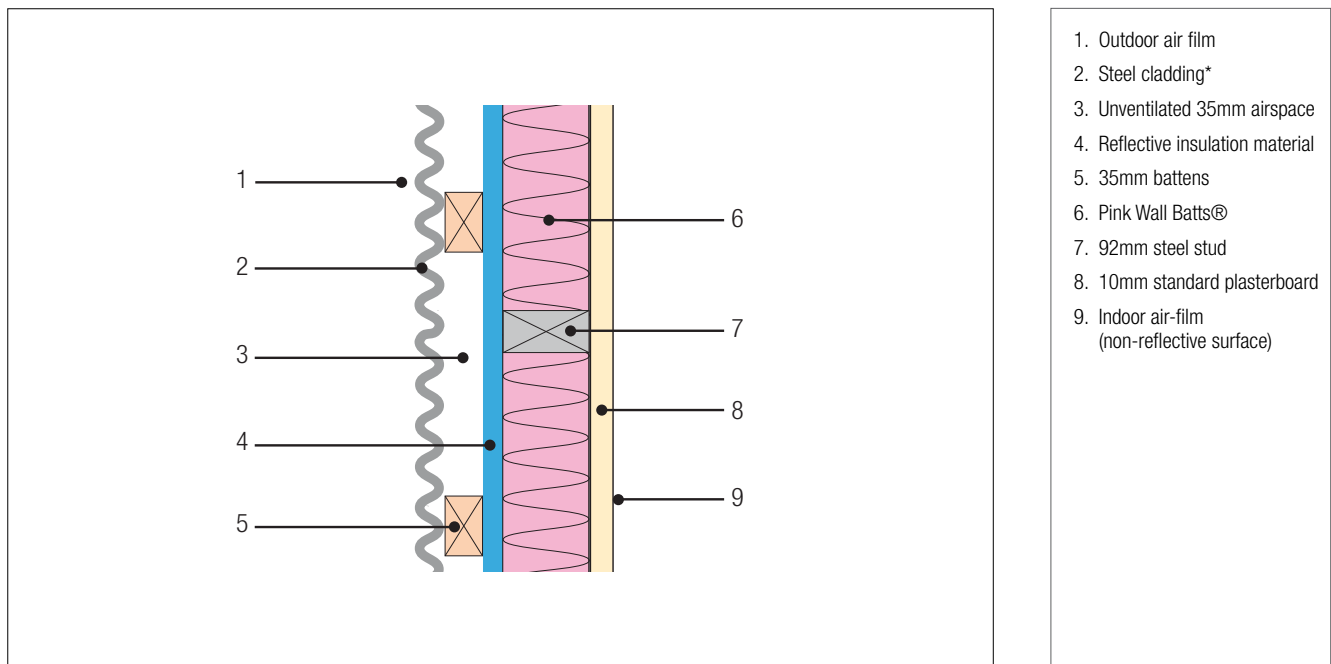

CAD illustrations: www.insulation.com.au/greenbook

CLIMATE ZONES 1-7 Direction of heat flow = Inward (Summer) for Climate Zones 1 to 2 (below 300m) Direction of heat flow = Outward (Winter) for Climate Zones 2 (above 300m) to 7 Minimum BCA = R2.8 *for 70mm studs	PRODUCT VARIATIONS	TOTAL SYSTEM R-VALUES		SOUND REDUCTION INDEX (Rw)	SYSTEM FEATURE
		WINTER	SUMMER		
	NON-VENTILATED				
	Titantuff™ Wall Wrap with R2.7 90mm Pink® SonoBatts® Premium	R3.3	R3.0	41	ME
	Tuffstuff™ Wall Wrap with R2.7 90mm Pink® SonoBatts® Premium	R3.3	R3.0	41	RE BV
	SisalTuff™ by Sisalation® with R2.1 70mm Pink® SonoBatts® Premium	R3.3	R3.0	41	
	Sisalation® 439 with R2.1 70mm Pink® SonoBatts® Premium*	R3.1	R2.8	41	
	InsulBubble™ 100 with R2.7 90mm Pink® SonoBatts® Premium	R3.9	R3.5	41	EE
	InsulMist® 650 with R2.7 90mm Pink® SonoBatts® Premium	R4.0	R3.6	41	
	InsulMist® 800 with R2.5 HD 90mm Pink Wall Batts®	R3.8	R3.5	41	
	Tyvek™ with R2.5 HD 90mm Pink Wall Batts®	R3.1	R2.8	41	

CLIMATE ZONES 8 Direction of heat flow = Outward (Winter) Minimum BCA = R3.8	PRODUCT VARIATIONS	TOTAL SYSTEM R-VALUES		SOUND REDUCTION INDEX (Rw)	SYSTEM FEATURE
		WINTER	SUMMER		
	NON-VENTILATED				
	Sisalation® 439 with R2.7 90mm Pink® SonoBatts® Premium	R3.8	R3.4	41	ME RE BV
	InsulBubble™ 100 with R2.7 90mm Pink® SonoBatts® Premium	R3.9	R3.5	41	TB EE
	InsulMist® 650 with R2.7 Pink® SonoBatts® Premium	R4.0	R3.6	41	
	InsulMist® 800 with R2.7 Pink® SonoBatts® Premium	R4.0	R3.7	41	

^ Required where steel trusses are used
* Rw calculation based on corrugated 0.48mm BMT steel cladding.

NOTES

- A: Calculations and assumptions in accordance with AS/NZS4859.1:2002 Including Amendment 1: 2006 on the path of insulation as required by BCA Volume 1. Part J and Volume 2. Section 3:12, 2011.
- B. Temperatures and Parameters are based on Australian climate assumptions. Air temperature difference 12°C (36°C less 24°C) for summer conditions and 6°C difference (18°C less 12°C) for winter. Actual conditions may differ from standardised conditions. This will impact on the actual performance of the insulation.
- C. Thermal resistance of air films and attic spaces based on values obtained from Section K5 and K6 of AS/NZS 4859.1: 2002 Including Amendment 1: 2006.
- D. Building material elements based on 2000 AIRAH Handbook and attic thermal value based on AS/NZS4859.1: 2002 Including Amendment 1: 2006 App K6 table K2.
- E. Where reflective insulation is installed, a simple addition of R-values is not possible. Care must be taken to ensure the performance of reflective air spaces is not 'double counted'.
- F. The emittance of the reflective surfaces are dependent on tested values and the conditions of the installation, as specified by AS/NZS4859.1: 2002 Including Amendment 1: 2006.
- G. All Residential roofing calculations in this handbook are based on a dark coloured roof. All Commercial roofing calculations in this handbook are based on a light coloured roof. Please refer to the colour absorbance chart for use of coloured roofs. Also refer to roofing material manufacturer's classification of type of colour for their range. Please contact 1800 000 878 for a customised solution.
- H. The Rw estimate tolerance is ± 3dB.

LEGEND:

- ME Most Economical
- RE Recommended
- BV Best Value
- TB Thermal Break
- EE Most Energy Efficient
- RW Best Sound Reduction
- FA Fall Arrest

SECTION 3: RESIDENTIAL WALL SYSTEMS

RESIDENTIAL CLAD TIMBER STUD WALL (LIGHTWEIGHT CLADDING FIXED DIRECT TO STUD)

STRUCTURE

Lightweight cladding fixed directly to stud over breather/permeable reflective insulation. Bright side of foil facing stud cavity. 90mm timber stud, non vented airspace or Pink Batts® insulation installed in cavity with 10mm plasterboard lining.

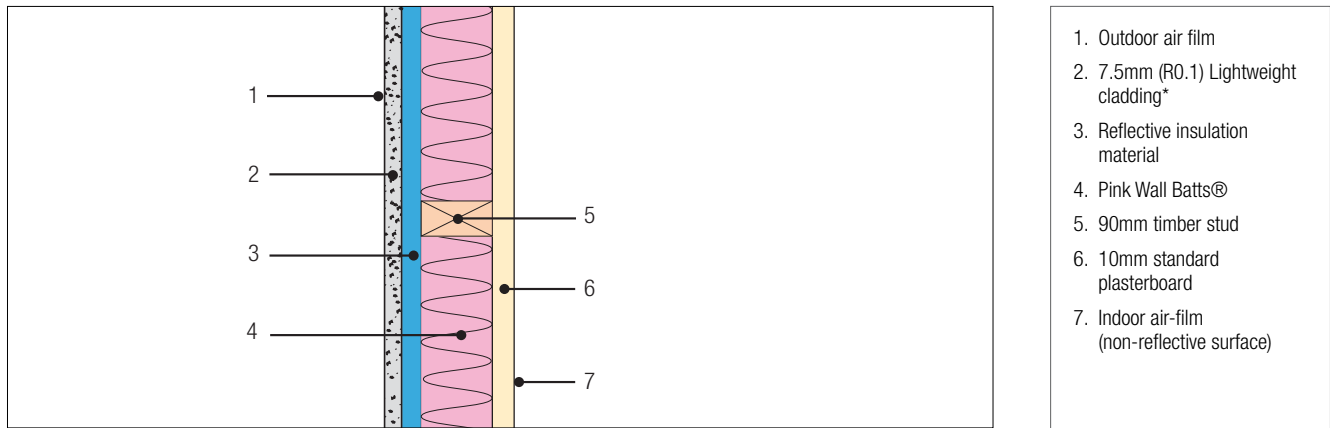

1. Outdoor air film
2. 7.5mm (R0.1) Lightweight cladding*
3. Reflective insulation material
4. Pink Wall Batts®
5. 90mm timber stud
6. 10mm standard plasterboard
7. Indoor air-film (non-reflective surface)

CAD illustrations: www.insulation.com.au/greenbook

CLIMATE ZONES 1-7	PRODUCT VARIATIONS	TOTAL SYSTEM R-VALUES		SOUND REDUCTION INDEX (Rw)	SYSTEM FEATURE
		WINTER	SUMMER		
Direction of heat flow = Inward (Summer) for Climate Zones 1 to 2 (below 300m) Direction of heat flow = Outward (Winter) for Climate Zones 2 (above 300m) to 7 Minimum BCA = R2.8	NON-VENTILATED				
	Titantuff™ Breather Wall Wrap with R2.7 90mm Pink® SonoBatts® Premium	R3.2	R2.9	41	ME
	Tuffstuff™ Breather Wall Wrap with R2.7 90mm Pink® SonoBatts® Premium	R3.2	R2.9	41	RE, BV, EE
	SisalTuff™ with R2.7 90mm Pink® SonoBatts® Premium	R3.2	R2.9	41	
	Tyvek™ with R2.7 90mm Pink® SonoBatts® Premium	R3.2	R2.9	41	
	InsulMist™ 650 Breather with R2.5HD 90mm Pink Wall Batts®	R3.2	R2.9	41	TB

^ Required where steel trusses are used
* Rw calculation based on Blueboard 7.5mm lightweight cladding.

CLIMATE ZONES 8	PRODUCT VARIATIONS	TOTAL SYSTEM R-VALUES		SOUND REDUCTION INDEX (Rw)	SYSTEM FEATURE
		WINTER	SUMMER		
Direction of heat flow = upward (winter) Minimum BCA = R3.8	NON-VENTILATED				
	Call 1800 000 878 for assistance			TBC	

NOTES

- A: Calculations and assumptions in accordance with AS/NZS4859.1:2002 Including Amendment 1: 2006 on the path of insulation as required by BCA Volume 1. Part J and Volume 2. Section 3:12, 2011.
- B: Temperatures and Parameters are based on Australian climate assumptions. Air temperature difference 12°C (36°C less 24°C) for summer conditions and 6°C difference (18°C less 12°C) for winter. Actual conditions may differ from standardised conditions. This will impact on the actual performance of the insulation.
- C: Thermal resistance of air films and attic spaces based on values obtained from Section K5 and K6 of AS/NZS 4859.1: 2002 Including Amendment 1: 2006.
- D: Building material elements based on 2000 AIRAH Handbook and attic thermal value based on AS/NZS4859.1: 2002 Including Amendment 1: 2006 App K6 table K2.
- E: Where reflective insulation is installed, a simple addition of R-values is not possible. Care must be taken to ensure the performance of reflective air spaces is not 'double counted'.
- F: The emittance of the reflective surfaces are dependent on tested values and the conditions of the installation, as specified by AS/NZS4859.1: 2002 Including Amendment 1: 2006.
- G: All Residential roofing calculations in this handbook are based on a dark coloured roof. All Commercial roofing calculations in this handbook are based on a light coloured roof. Please refer to the colour absorbance chart for use of coloured roofs. Also refer to roofing material manufacturer's classification of type of colour for their range. Please contact 1800 000 878 for a customised solution.
- H: The Rw estimate tolerance is ± 3dB.

- LEGEND:
- ME Most Economical
 - RE Recommended
 - BV Best Value
 - TB Thermal Break
 - EE Most Energy Efficient
 - RW Best Sound Reduction
 - FA Fall Arrest

SECTION 3: RESIDENTIAL WALL SYSTEMS

RESIDENTIAL CAVITY CLAY MASONRY WALL (DOUBLE BRICK)

STRUCTURE

Double brick wall with 50mm brick cavity with reflective foil insulation mid-point of cavity (by use of spacers). (Note: cavity dimensions adjusted to compensate for reflective foil laminates having a thickness of greater than 1mm). Bright side of foil facing inwards. Non vented airspace of bulk insulation installed in cavity with 10mm plasterboard lining or cement render.

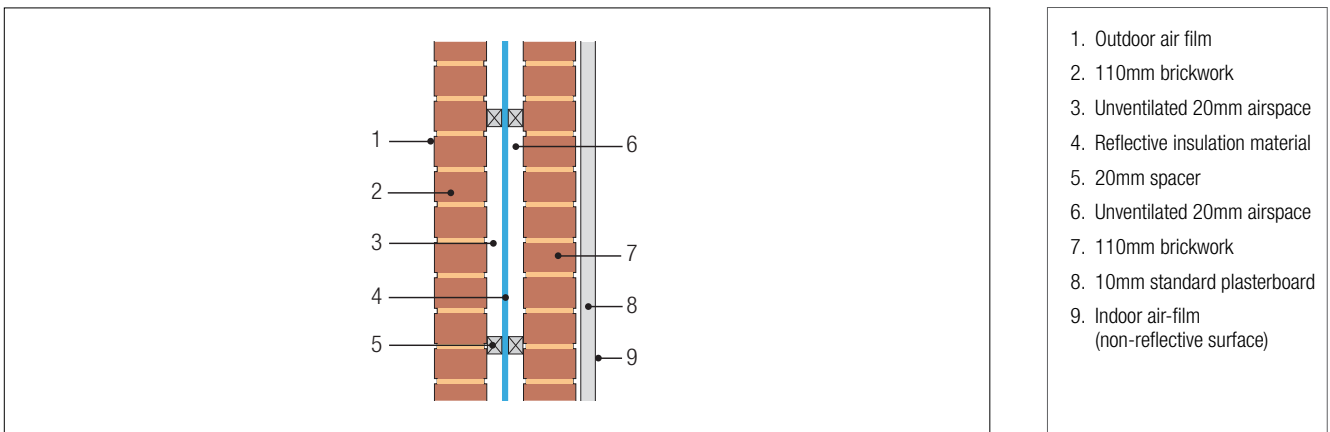

1. Outdoor air film
2. 110mm brickwork
3. Unventilated 20mm airspace
4. Reflective insulation material
5. 20mm spacer
6. Unventilated 20mm airspace
7. 110mm brickwork
8. 10mm standard plasterboard
9. Indoor air-film (non-reflective surface)

CAD illustrations: www.insulation.com.au/greenbook

CLIMATE ZONES 1-7	PRODUCT VARIATIONS	TOTAL SYSTEM R-VALUES		SOUND REDUCTION INDEX (R _w)	SYSTEM FEATURE
		WINTER	SUMMER		
Direction of heat flow = Inward (Summer) for Climate Zones 1 to 2 (below 300m)	NON-VENTILATED				
	InsulBubble™ 100	R2.2	R2.0	53	
	InsulBubble™ 200	R2.2	R2.0	53	ME RE BV EE
Direction of heat flow = Outward (Winter) for Climate Zones 2 (above 300m) to 7					
Minimum BCA = R2.8					

^ Required where steel trusses are used

CLIMATE ZONES 8	PRODUCT VARIATIONS	TOTAL SYSTEM R-VALUES		SOUND REDUCTION INDEX (R _w)	SYSTEM FEATURE
		WINTER	SUMMER		
Direction of heat flow = Outward (Winter)	NON-VENTILATED				
	Call 1800 000 878 for a solution			TBC	
Minimum BCA = R3.8					

NOTES

- A: Calculations and assumptions in accordance with AS/NZS4859.1:2002 Including Amendment 1: 2006 on the path of insulation as required by BCA Volume 1. Part J and Volume 2. Section 3:12, 2011.
- B. Temperatures and Parameters are based on Australian climate assumptions. Air temperature difference 12°C (36°C less 24°C) for summer conditions and 6°C difference (18°C less 12°C) for winter. Actual conditions may differ from standardised conditions. This will impact on the actual performance of the insulation.
- C. Thermal resistance of air films and attic spaces based on values obtained from Section K5 and K6 of AS/NZS 4859.1: 2002 Including Amendment 1: 2006.
- D. Building material elements based on 2000 AIRAH Handbook and attic thermal value based on AS/NZS4859.1: 2002 Including Amendment 1: 2006 App K6 table K2.
- E. Where reflective insulation is installed, a simple addition of R-values is not possible. Care must be taken to ensure the performance of reflective air spaces is not 'double counted'.
- F. The emittance of the reflective surfaces are dependent on tested values and the conditions of the installation, as specified by AS/NZS4859.1: 2002 Including Amendment 1: 2006.
- G. All Residential roofing calculations in this handbook are based on a dark coloured roof. All Commercial roofing calculations in this handbook are based on a light coloured roof. Please refer to the colour absorbance chart for use of coloured roofs. Also refer to roofing material manufacturer's classification of type of colour for their range. Please contact 1800 000 878 for a customised solution.
- H. The R_w estimate tolerance is ± 3dB.

LEGEND:

- ME** Most Economical
- RE** Recommended
- BV** Best Value
- TB** Thermal Break
- EE** Most Energy Efficient
- RW** Best Sound Reduction
- FA** Fall Arrest

SECTION 3: RESIDENTIAL WALL SYSTEMS

RESIDENTIAL REVERSE BRICK VENEER WALL (EXTERNAL CLADDING FIXED DIRECTLY TO STUD)

STRUCTURE

8mm fibre cement sheet external cladding fixed to stud. Breather foil to outside of stud frame, bright side of foil facing stud cavity. 90mm timber stud frame filled with Pink Batts® insulation. Breather foil to inside of stud frame, bright side of foil facing 40mm airspace. 110mm bricks and 10mm plasterboard internal lining.

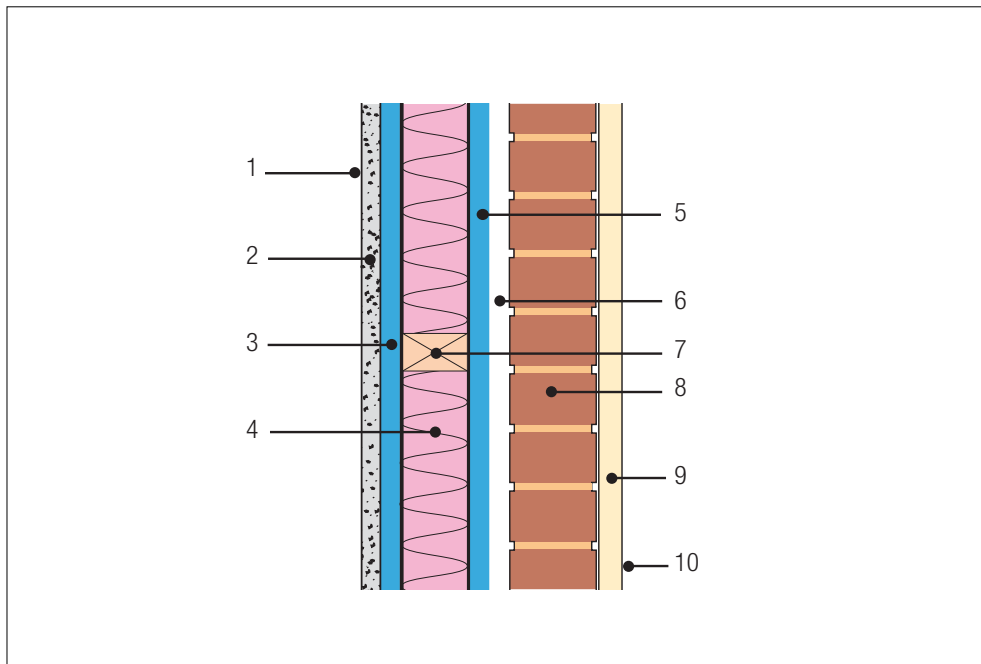

1. Outdoor air film
2. 8mm compressed fibre cement sheet
3. Reflective insulation material
4. Pink Wall Batts®
5. Reflective foil insulation
6. 30mm unventilated airspace
7. 90mm timber stud
8. 110mm brickwork
9. 10mm standard plasterboard
10. Indoor air-film (non-reflective surface)

CAD illustrations: www.insulation.com.au/greenbook

CLIMATE ZONES 1-7	PRODUCT VARIATIONS	TOTAL SYSTEM R-VALUES		SOUND REDUCTION INDEX (Rw)	SYSTEM FEATURE
		WINTER	SUMMER		
Direction of heat flow = Inward (Summer) for Climate Zones 1 to 2 (below 300m) Direction of heat flow = Outward (Winter) for Climate Zones 2 (above 300m) to 7 Minimum BCA = R2.8 *for 70mm studs	NON-VENTILATED				
	2 layers Titantuff™ Breather Wall Wrap with R2.5 HD 90mm Pink Wall Batts®	R4.0	R3.6	73	ME
	2 layers Tuffstuff™ Breather Wall Wrap with R2.5 HD 90mm Pink Wall Batts®	R4.0	R3.6	73	RE BV
	Titantuff™ Breather Wall Wrap with R2.5 HD 90mm Pink Wall Batts and InsulBubble™ 100	R4.1	R3.7	73	
	Titantuff™ Breather Wall Wrap with R2.5 HD 90mm Pink Wall Batts and InsulMist® 650	R4.2	R3.8	73	EE
	2 layers InsulMist 650 Breather with R2.5 HD 90mm Pink Wall Batts®	R3.9	R3.6	73	TB
	2 layers InsulMist 800 Breather with R2.0 HD 70mm Pink Wall Batts®*	R3.9	R3.6	73	TB
	2 layers Titantuff™ Breather Wall Wrap with R2.7 90mm Pink® SonoBatts® Premium	R4.2	R3.7	73	

CLIMATE ZONE 8	PRODUCT VARIATIONS	TOTAL SYSTEM R-VALUES		SOUND REDUCTION INDEX (Rw)	SYSTEM FEATURE
		WINTER	SUMMER		
Direction of heat flow = Outward (Winter) Minimum BCA = R3.8	NON-VENTILATED				
	2 layers InsulBubble™ with R2.7 90mm Pink® SonoBatts® Premium	R4.4	R4.0	73	RE BV
	2 layers InsulBubble™ with R2.5 90mm HD Wall Batts®	R4.2	R3.8	73	ME
	2 layers InsulMist® 650 with R2.7 90mm Pink® SonoBatts® Premium	R4.6	R4.1	73	TB
	2 layers InsulMist® 800 with R2.7 90mm Pink® SonoBatts® Premium	R4.7	R4.2	73	TB EE
	2 layers InsulMist® 800 with R2.5 90mm HD Wall Batts	R4.5	R4.1	73	TB

^ Required where steel trusses are used

NOTES

- A: Calculations and assumptions in accordance with AS/NZS4859.1:2002 Including Amendment 1: 2006 on the path of insulation as required by BCA Volume 1. Part J and Volume 2. Section 3:12, 2011.
- B. Temperatures and Parameters are based on Australian climate assumptions. Air temperature difference 12°C (36°C less 24°C) for summer conditions and 6°C difference (18°C less 12°C) for winter. Actual conditions may differ from standardised conditions. This will impact on the actual performance of the insulation.
- C. Thermal resistance of air films and attic spaces based on values obtained from Section K5 and K6 of AS/NZS 4859.1: 2002 Including Amendment 1: 2006.
- D. Building material elements based on 2000 AIRAH Handbook and attic thermal value based on AS/NZS4859.1: 2002 Including Amendment 1: 2006 App K6 table K2.
- E. Where reflective insulation is installed, a simple addition of R-values is not possible. Care must be taken to ensure the performance of reflective air spaces is not 'double counted'.
- F. The emittance of the reflective surfaces are dependent on tested values and the conditions of the installation, as specified by AS/NZS4859.1: 2002 Including Amendment 1: 2006.
- G. All Residential roofing calculations in this handbook are based on a dark coloured roof. All Commercial roofing calculations in this handbook are based on a light coloured roof. Please refer to the colour absorbance chart for use of coloured roofs. Also refer to roofing material manufacturer's classification of type of colour for their range. Please contact 1800 000 878 for a customised solution.
- H. The Rw estimate tolerance is ± 3dB.

- LEGEND:
- ME Most Economical
 - RE Recommended
 - BV Best Value
 - TB Thermal Break
 - EE Most Energy Efficient
 - RW Best Sound Reduction
 - FA Fall Arrest

SECTION 3: RESIDENTIAL WALL SYSTEMS

INTERNAL TIMBER FRAME WALL 10MM STANDARD PLASTERBOARD

STRUCTURE

Internal timber stud wall with plasterboard lining.

INSULATION INSTALLATION

Install insulation in between stud work behind plasterboard.

Make sure all gaps are sealed and that insulation is not thicker than the stud wall as deformation of plasterboard may occur.

Ensure insulation is not in contact with electrical plugs or light fittings.

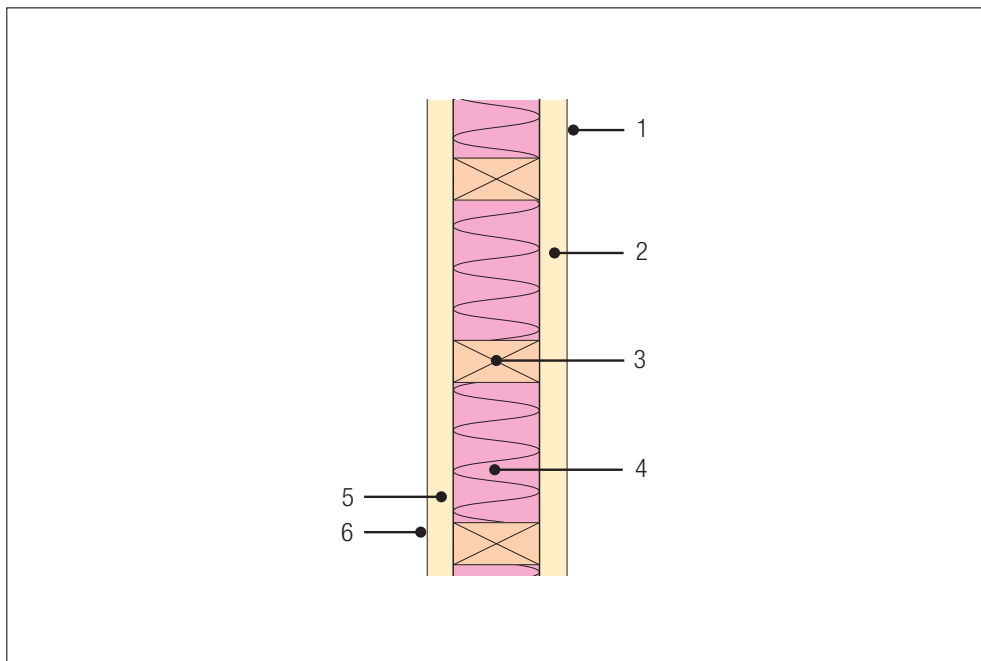

1. Indoor Air Film (Non-reflective)
2. 10mm standard plasterboard
3. Timber wall studs
4. Pink® SonoBatts® or Pink® SonoBatts® Premium Acoustic Insulation
5. 10mm Plasterboard
6. Indoor Air Film (Non-reflective)

CAD illustrations: www.insulation.com.au/greenbook

ALL CLIMATE ZONES	PRODUCT VARIATION	THERMAL Total R Value	ACOUSTIC Rw (Rw + Ctr)	SYSTEM FEATURE
(side 1) 1 layer 10mm Standard Plasterboard (side 2) 1 layer 10mm Standard Plasterboard	70mm Stud Wall (90mm overall wall width)			
	No Insulation	R0.4	Rw 33 (25)	
	70mm R1.7 Pink® SonoBatts®	R2.1	Rw 37 (28)	ME
	70mm R2.1 Pink® SonoBatts® Premium	R2.5	Rw 38 (29)	RE, EE, RW
	90mm Stud Wall (110mm overall wall width)			
	No Insulation	R0.4	Rw 34 (25)	
	90mm R2.1 Pink® SonoBatts®	R2.5	Rw 38 (28)	ME
	90mm R2.7 Pink® SonoBatts® Premium	R2.9	Rw 39 (30)	RE, EE, RW

ALL CLIMATE ZONES	PRODUCT VARIATION	THERMAL Total R Value	ACOUSTIC Rw (Rw + Ctr)	SYSTEM FEATURE
(side 1) 1 layer 10mm Standard Plasterboard (side 2) 2 layer 10mm Standard Plasterboard	70mm Stud Wall (90mm overall wall width)			
	No Insulation	R0.4	Rw 37 (30)	
	70mm R1.7 Pink® SonoBatts®	R2.1	Rw 41 (33)	ME
	70mm R2.1 Pink® SonoBatts® Premium	R2.5	Rw 42 (34)	RE, EE, RW
	90mm Stud Wall (110mm overall wall width)			
	No Insulation	R0.4	Rw 38 (30)	
	90mm R2.1 Pink® SonoBatts®	R2.5	Rw 42 (33)	ME
	90mm R2.7 Pink® SonoBatts® Premium	R2.9	Rw 43 (34)	RE, EE, RW

ALL CLIMATE ZONES	PRODUCT VARIATION	THERMAL Total R Value	ACOUSTIC Rw (Rw + Ctr)	SYSTEM FEATURE
(side 1) 2 layer 10mm Standard Plasterboard (side 2) 2 layer 10mm Standard Plasterboard	70mm Stud Wall (90mm overall wall width)			
	No Insulation	R0.5	Rw 41 (33)	
	70mm R1.7 Pink® SonoBatts®	R2.2	Rw 44 (36)	ME
	70mm R2.1 Pink® SonoBatts® Premium	R2.6	Rw 45 (37)	RE, BV, EE
	90mm Stud Wall (110mm overall wall width)			
	No Insulation	R0.5	Rw 41 (33)	
	90mm R2.1 Pink® SonoBatts®	R2.6	Rw 46 (37)	ME
	90mm R2.7 Pink® SonoBatts® Premium	R3.0	Rw 47 (38)	RE, EE, RW

NOTES

- A. Calculations and assumptions in accordance with AS/NZS4859.1:2002 Including Amendment 1: 2006 on the path of insulation as required by BCA Volume 1. Part J and Volume 2. Section 3:12, 2011.
- B. Temperatures and Parameters are based on Australian climate assumptions. Air temperature difference 12°C (36°C less 24°C) for summer conditions and 6°C difference (18°C less 12°C) for winter. Actual conditions may differ from standardised conditions. This will impact on the actual performance of the insulation.
- C. Thermal resistance of air films and attic spaces based on values obtained from Section K5 and K6 of AS/NZS 4859.1: 2002 Including Amendment 1: 2006.
- D. Building material elements based on 2000 AIRAH Handbook and attic thermal value based on AS/NZS4859.1: 2002 Including Amendment 1: 2006 App K6 table K2.
- E. Where reflective insulation is installed, a simple addition of R-values is not possible. Care must be taken to ensure the performance of reflective air spaces is not 'double counted'.
- F. The emittance of the reflective surfaces are dependent on tested values and the conditions of the installation, as specified by AS/NZS4859.1: 2002 Including Amendment 1: 2006.
- G. All Residential roofing calculations in this handbook are based on a dark coloured roof. All Commercial roofing calculations in this handbook are based on a light coloured roof. Please refer to the colour absorbance chart for use of coloured roofs. Also refer to roofing material manufacturer's classification of type of colour for their range. Please contact 1800 000 878 for a customised solution.
- H. The Rw estimate tolerance is ± 3dB.

LEGEND:

- ME Most Economical
RE Recommended
BV Best Value
TB Thermal Break
EE Most Energy Efficient
RW Best Sound Reduction
FA Fall Arrest

SECTION 3: RESIDENTIAL WALL SYSTEMS

INTERNAL TIMBER FRAME WALL 10mm ACOUSTIC PLASTERBOARD

STRUCTURE

Internal timber stud wall with plasterboard lining.

INSULATION INSTALLATION

Install insulation in between stud work behind plasterboard.

Make sure all gaps are sealed and that insulation is not thicker than the stud wall as deformation of plasterboard may occur.

Ensure insulation is not in contact with electrical plugs or light fittings.

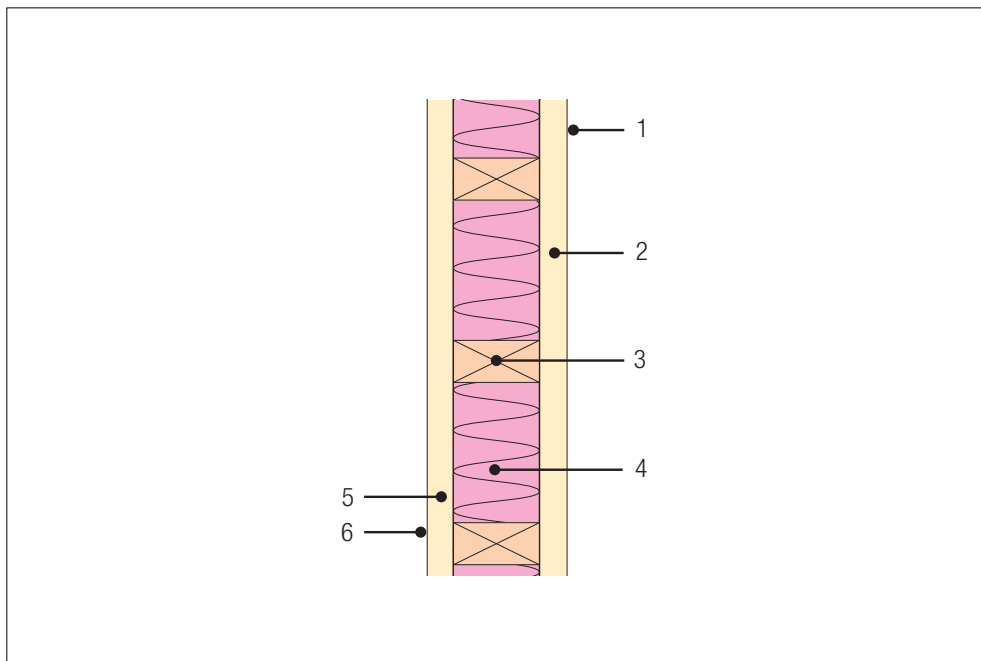

1. Indoor Air Film (non-reflective)
2. 10mm acoustic plasterboard
3. Timber wall studs
4. Pink® SonoBatts® or Pink® SonoBatts® Premium Acoustic Insulation
5. 10mm Plasterboard
6. Indoor Air Film (Non-reflective)

CAD illustrations: www.insulation.com.au/greenbook

ALL CLIMATE ZONES	PRODUCT VARIATION	THERMAL Total R Value	ACOUSTIC Rw (Rw + Ctr)	SYSTEM FEATURE
(side 1) 1 layer 10mm Board (side 2) 1 layer 10mm board	70mm Stud Wall (90mm overall wall width)			
	No Insulation	R0.4	Rw 37 (30)	
	70mm R1.7 Pink® SonoBatts®	R2.1	Rw 41 (33)	ME
	70mm R2.1 Pink® SonoBatts® Premium	R2.5	Rw 42 (34)	RE TB EE RW
	90mm Stud Wall (110mm overall wall width)			
	No Insulation	R0.4	Rw 38 (30)	
	90mm R2.1 Pink® SonoBatts®	R2.5	Rw 42 (34)	ME
	90mm R2.7 Pink® SonoBatts® Premium	R2.9	Rw 42 (36)	RE TB EE RW

ALL CLIMATE ZONES	PRODUCT VARIATION	THERMAL Total R Value	ACOUSTIC Rw (Rw + Ctr)	SYSTEM FEATURE
(side 1) 1 layer 10mm Board (side 2) 2 layer 10mm board	70mm Stud Wall (90mm overall wall width)			
	No Insulation	R0.4	Rw 39 (32)	
	70mm R1.7 Pink® SonoBatts®	R2.1	Rw 44 (35)	ME
	70mm R2.1 Pink® SonoBatts® Premium	R2.5	Rw 45 (37)	RE TB EE RW
	90mm Stud Wall (110mm overall wall width)			
	No Insulation	R0.4	Rw 40 (32)	
	90mm R2.1 Pink® SonoBatts®	R2.5	Rw 44 (37)	ME
	90mm R2.7 Pink® SonoBatts® Premium	R2.9	Rw 45 (38)	RE TB EE RW

ALL CLIMATE ZONES	PRODUCT VARIATION	THERMAL Total R Value	ACOUSTIC Rw (Rw + Ctr)	SYSTEM FEATURE
(side 1) 2 layer 10mm Board (side 2) 2 layer 10mm board	70mm Stud Wall (90mm overall wall width)			
	No Insulation	R0.5	Rw 42 (35)	
	70mm R1.7 Pink® SonoBatts®	R2.2	Rw 46 (39)	ME
	70mm R2.1 Pink® SonoBatts® Premium	R2.6	Rw 47 (40)	RE TB BV EE
	90mm Stud Wall (110mm overall wall width)			
	No Insulation	R0.5	Rw 43 (36)	
	90mm R2.1 Pink® SonoBatts®	R2.6	Rw 47 (40)	ME
	90mm R2.7 Pink® SonoBatts® Premium	R3.0	Rw 48 (41)	RE TB EE RW

NOTES

- A. Calculations and assumptions in accordance with AS/NZS4859.1:2002 Including Amendment 1: 2006 on the path of insulation as required by BCA Volume 1. Part J and Volume 2. Section 3:12, 2011.
- B. Temperatures and Parameters are based on Australian climate assumptions. Air temperature difference 12°C (36°C less 24°C) for summer conditions and 6°C difference (18°C less 12°C) for winter. Actual conditions may differ from standardised conditions. This will impact on the actual performance of the insulation.
- C. Thermal resistance of air films and attic spaces based on values obtained from Section K5 and K6 of AS/NZS 4859.1: 2002 Including Amendment 1: 2006.
- D. Building material elements based on 2000 AIRAH Handbook and attic thermal value based on AS/NZS4859.1: 2002 Including Amendment 1: 2006 App K6 table K2.
- E. Where reflective insulation is installed, a simple addition of R-values is not possible. Care must be taken to ensure the performance of reflective air spaces is not 'double counted'.
- F. The emittance of the reflective surfaces are dependent on tested values and the conditions of the installation, as specified by AS/NZS4859.1: 2002 Including Amendment 1: 2006.
- G. All Residential roofing calculations in this handbook are based on a dark coloured roof. All Commercial roofing calculations in this handbook are based on a light coloured roof. Please refer to the colour absorbance chart for use of coloured roofs. Also refer to roofing material manufacturer's classification of type of colour for their range. Please contact 1800 000 878 for a customised solution.
- H. The Rw estimate tolerance is ± 3dB.

LEGEND:

- ME Most Economical
RE Recommended
BV Best Value
TB Thermal Break
EE Most Energy Efficient
RW Best Sound Reduction
FA Fall Arrest

SECTION 3: RESIDENTIAL WALL SYSTEMS

INTERNAL STEEL FRAME WALL 10mm STANDARD PLASTERBOARD

STRUCTURE

Internal steel stud wall with plasterboard lining.

INSULATION INSTALLATION

Install insulation in between stud work behind plasterboard.

Make sure all gaps are sealed and that insulation is not thicker than the stud wall as deformation of plasterboard may occur.

Ensure insulation is not in contact with electrical plugs or light fittings.

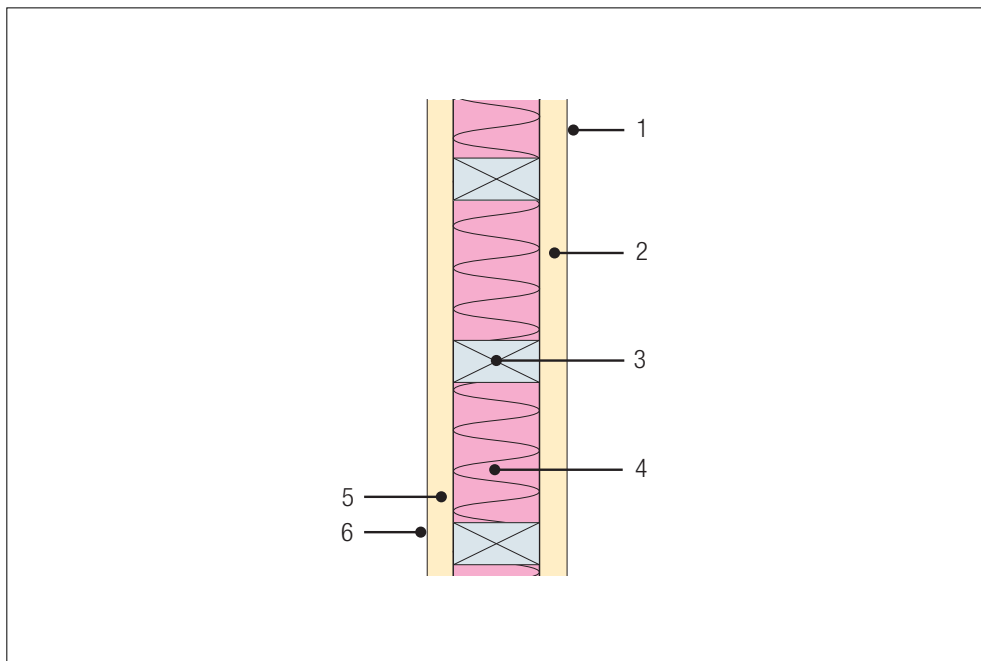

1. Indoor air film (non-reflective)
2. 10mm acoustic plasterboard
3. Steel wall studs
4. Pink® SonoBatts® or Pink® SonoBatts® Premium Acoustic Insulation
5. 10mm acoustic plasterboard
6. Indoor Air Film (Non-reflective)

CAD illustrations: www.insulation.com.au/greenbook

ALL CLIMATE ZONES	PRODUCT VARIATION	THERMAL Total R Value	ACOUSTIC Rw (Rw + Ctr)	SYSTEM FEATURE
(side 1) 1 layer 10mm Standard Plasterboard (side 2) 1 layer 10mm Standard Plasterboard	76mm Stud Wall (96mm overall wall width)			
	No Insulation	R0.4	Rw 34 (26)	
	70mm R1.7 Pink® SonoBatts®	R2.1	Rw 43 (34)	ME
	70mm R2.1 Pink® SonoBatts® Premium	R2.5	Rw 44 (35)	TB RE EE RW
	92mm Stud Wall (112mm overall wall width)			
	No Insulation	R0.4	Rw 35 (27)	
	90mm R2.1 Pink® SonoBatts®	R2.5	Rw 43 (34)	ME
	90mm R2.7 Pink® SonoBatts® Premium	R2.9	Rw 44 (35)	TB RE RW

ALL CLIMATE ZONES	PRODUCT VARIATION	THERMAL Total R Value	ACOUSTIC Rw (Rw + Ctr)	SYSTEM FEATURE
(side 1) 1 layer 10mm Standard Plasterboard (side 2) 2 layer 10mm Standard Plasterboard	76mm Stud Wall (96mm overall wall width)			
	No Insulation	R0.4	Rw 40 (31)	
	70mm R1.7 Pink® SonoBatts®	R2.1	Rw 48 (37)	ME
	70mm R2.1 Pink® SonoBatts® Premium	R2.5	Rw 49 (38)	TB RE EE RW
	92mm Stud Wall (112mm overall wall width)			
	No Insulation	R0.4	Rw 40 (31)	
	90mm R2.1 Pink® SonoBatts®	R2.5	Rw 49 (39)	ME
	90mm R2.7 Pink® SonoBatts® Premium	R2.9	Rw 50 (37)	TB RE RW

ALL CLIMATE ZONES	PRODUCT VARIATION	THERMAL Total R Value	ACOUSTIC Rw (Rw + Ctr)	SYSTEM FEATURE
(side 1) 2 layer 10mm Standard Plasterboard (side 2) 2 layer 10mm Standard Plasterboard	76mm Stud Wall (96mm overall wall width)			
	No Insulation	R0.5	Rw 44 (34)	
	70mm R1.7 Pink® SonoBatts®	R2.2	Rw 52 (43)	ME
	70mm R2.1 Pink® SonoBatts® Premium	R2.6	Rw 53 (44)	TB RE BV EE
	92mm Stud Wall (112mm overall wall width)			
	No Insulation	R0.5	Rw 45 (34)	
	90mm R2.1 Pink® SonoBatts®	R2.6	Rw 53 (44)	ME
	90mm R2.7 Pink® SonoBatts® Premium	R3.0	Rw 54 (45)	TB RE RW

NOTES

- A. Calculations and assumptions in accordance with AS/NZS4859.1:2002 Including Amendment 1: 2006 on the path of insulation as required by BCA Volume 1. Part J and Volume 2. Section 3:12, 2011.
- B. Temperatures and Parameters are based on Australian climate assumptions. Air temperature difference 12°C (36°C less 24°C) for summer conditions and 6°C difference (18°C less 12°C) for winter. Actual conditions may differ from standardised conditions. This will impact on the actual performance of the insulation.
- C. Thermal resistance of air films and attic spaces based on values obtained from Section K5 and K6 of AS/NZS 4859.1: 2002 Including Amendment 1: 2006.
- D. Building material elements based on 2000 AIRAH Handbook and attic thermal value based on AS/NZS4859.1: 2002 Including Amendment 1: 2006 App K6 table K2.
- E. Where reflective insulation is installed, a simple addition of R-values is not possible. Care must be taken to ensure the performance of reflective air spaces is not 'double counted'.
- F. The emittance of the reflective surfaces are dependent on tested values and the conditions of the installation, as specified by AS/NZS4859.1: 2002 Including Amendment 1: 2006.
- G. All Residential roofing calculations in this handbook are based on a dark coloured roof. All Commercial roofing calculations in this handbook are based on a light coloured roof. Please refer to the colour absorbance chart for use of coloured roofs. Also refer to roofing material manufacturer's classification of type of colour for their range. Please contact 1800 000 878 for a customised solution.
- H. The Rw estimate tolerance is ± 3dB.

LEGEND:

- ME Most Economical
RE Recommended
BV Best Value
TB Thermal Break
EE Most Energy Efficient
RW Best Sound Reduction
FA Fall Arrest

SECTION 3: RESIDENTIAL WALL SYSTEMS

INTERNAL STEEL FRAME WALL 10mm ACOUSTIC PLASTERBOARD

STRUCTURE

Internal steel stud wall with plasterboard lining.

INSULATION INSTALLATION

Install insulation in between stud work behind plasterboard.

Make sure all gaps are sealed and that insulation is not thicker than the stud wall as deformation of plasterboard may occur.

Ensure insulation is not in contact with electrical plugs or light fittings.

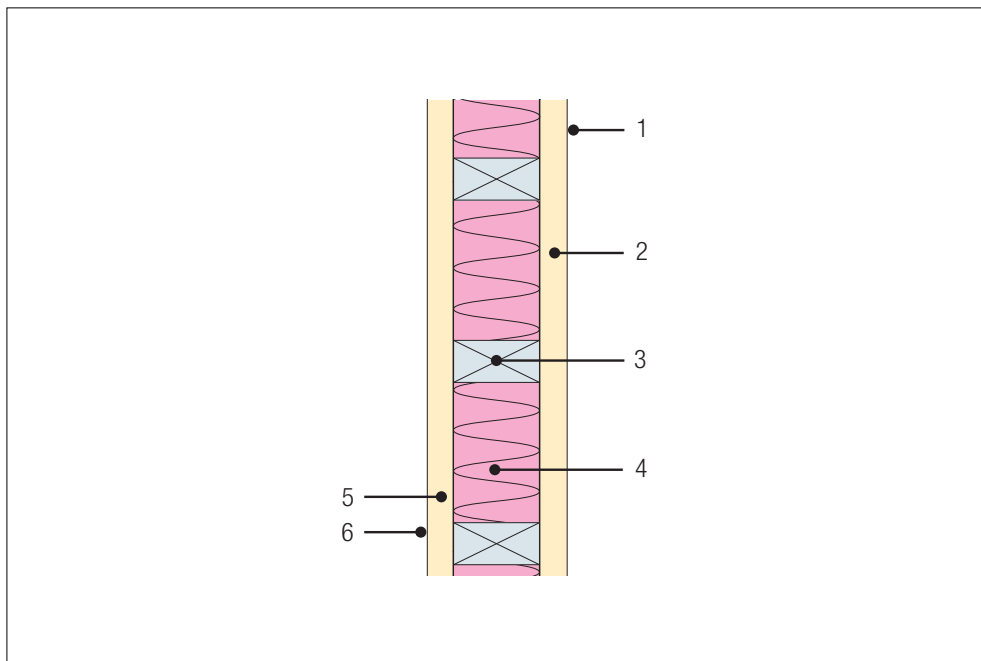

1. Indoor Air Film (non-reflective)
2. 10mm standard plasterboard
3. Steel wall studs
4. Pink® SonoBatts® or Pink® SonoBatts® Premium Acoustic Insulation
5. 10mm Plasterboard
6. Indoor Air Film (Non-reflective)

CAD illustrations: www.insulation.com.au/greenbook

ALL CLIMATE ZONES	PRODUCT VARIATION	THERMAL Total R Value	ACOUSTIC Rw (Rw + Ctr)	SYSTEM FEATURE
(side 1) 1 layer 10mm Standard Plasterboard (side 2) 1 layer 10mm Standard Plasterboard	76mm Stud Wall (96mm overall wall width)			
	No Insulation	R0.4	Rw 33 (24)	
	70mm R1.7 Pink® SonoBatts®	R2.1	Rw 39 (30)	ME
	70mm R2.1 Pink® SonoBatts® Premium	R2.5	Rw 40 (31)	RE TB EE RW
	92mm Stud Wall (112mm overall wall width)			
	No Insulation	R0.4	Rw 33 (25)	
	90mm R2.1 Pink® SonoBatts®	R2.5	Rw 40 (31)	ME
	90mm R2.7 Pink® SonoBatts® Premium	R2.9	Rw 41 (32)	RE TB EE RW

ALL CLIMATE ZONES	PRODUCT VARIATION	THERMAL Total R Value	ACOUSTIC Rw (Rw + Ctr)	SYSTEM FEATURE
(side 1) 1 layer 10mm Standard Plasterboard (side 2) 2 layer 10mm Standard Plasterboard	76mm Stud Wall (96mm overall wall width)			
	No Insulation	R0.4	Rw 38 (29)	
	70mm R1.7 Pink® SonoBatts®	R2.1	Rw 44 (35)	ME
	70mm R2.1 Pink® SonoBatts® Premium	R2.5	Rw 45 (36)	RE TB EE RW
	92mm Stud Wall (112mm overall wall width)			
	No Insulation	R0.4	Rw 38 (29)	
	90mm R2.1 Pink® SonoBatts®	R2.5	Rw 45 (35)	ME
	90mm R2.7 Pink® SonoBatts® Premium	R2.9	Rw 46 (36)	RE TB EE RW

ALL CLIMATE ZONES	PRODUCT VARIATION	THERMAL Total R Value	ACOUSTIC Rw (Rw + Ctr)	SYSTEM FEATURE
(side 1) 2 layer 10mm Standard Plasterboard (side 2) 2 layer 10mm Standard Plasterboard	76mm Stud Wall (96mm overall wall width)			
	No Insulation	R0.5	Rw 41 (32)	
	70mm R1.7 Pink® SonoBatts®	R2.2	Rw 49 (39)	ME
	70mm R2.1 Pink® SonoBatts® Premium	R2.6	Rw 50 (40)	RE TB BV EE
	92mm Stud Wall (112mm overall wall width)			
	No Insulation	R0.5	Rw 42 (32)	
	90mm R2.1 Pink® SonoBatts®	R2.6	Rw 50 (40)	ME
	90mm R2.7 Pink® SonoBatts® Premium	R3.0	Rw 51 (41)	RE TB EE RW

NOTES

- A: Calculations and assumptions in accordance with AS/NZS4859.1:2002 Including Amendment 1: 2006 on the path of insulation as required by BCA Volume 1. Part J and Volume 2. Section 3:12, 2011.
- B. Temperatures and Parameters are based on Australian climate assumptions. Air temperature difference 12°C (36°C less 24°C) for summer conditions and 6°C difference (18°C less 12°C) for winter. Actual conditions may differ from standardised conditions. This will impact on the actual performance of the insulation.
- C. Thermal resistance of air films and attic spaces based on values obtained from Section K5 and K6 of AS/NZS 4859.1: 2002 Including Amendment 1: 2006.
- D. Building material elements based on 2000 AIRAH Handbook and attic thermal value based on AS/NZS4859.1: 2002 Including Amendment 1: 2006 App K6 table K2.
- E. Where reflective insulation is installed, a simple addition of R-values is not possible. Care must be taken to ensure the performance of reflective air spaces is not 'double counted'.
- F. The emittance of the reflective surfaces are dependent on tested values and the conditions of the installation, as specified by AS/NZS4859.1: 2002 Including Amendment 1: 2006.
- G. All Residential roofing calculations in this handbook are based on a dark coloured roof. All Commercial roofing calculations in this handbook are based on a light coloured roof. Please refer to the colour absorbance chart for use of coloured roofs. Also refer to roofing material manufacturer's classification of type of colour for their range. Please contact 1800 000 878 for a customised solution.
- H. The Rw estimate tolerance is ± 3dB.

LEGEND:

- ME Most Economical
RE Recommended
BV Best Value
TB Thermal Break
EE Most Energy Efficient
RW Best Sound Reduction
FA Fall Arrest

This page is left blank intentionally

Section 4: Residential floor systems

Residential suspended timber floor.
Pg 60

Ceiling under floor (option 1). Pg 61

Ceiling under floor (option 2). Pg 62

Ceiling under floor (fire rated). Pg 63

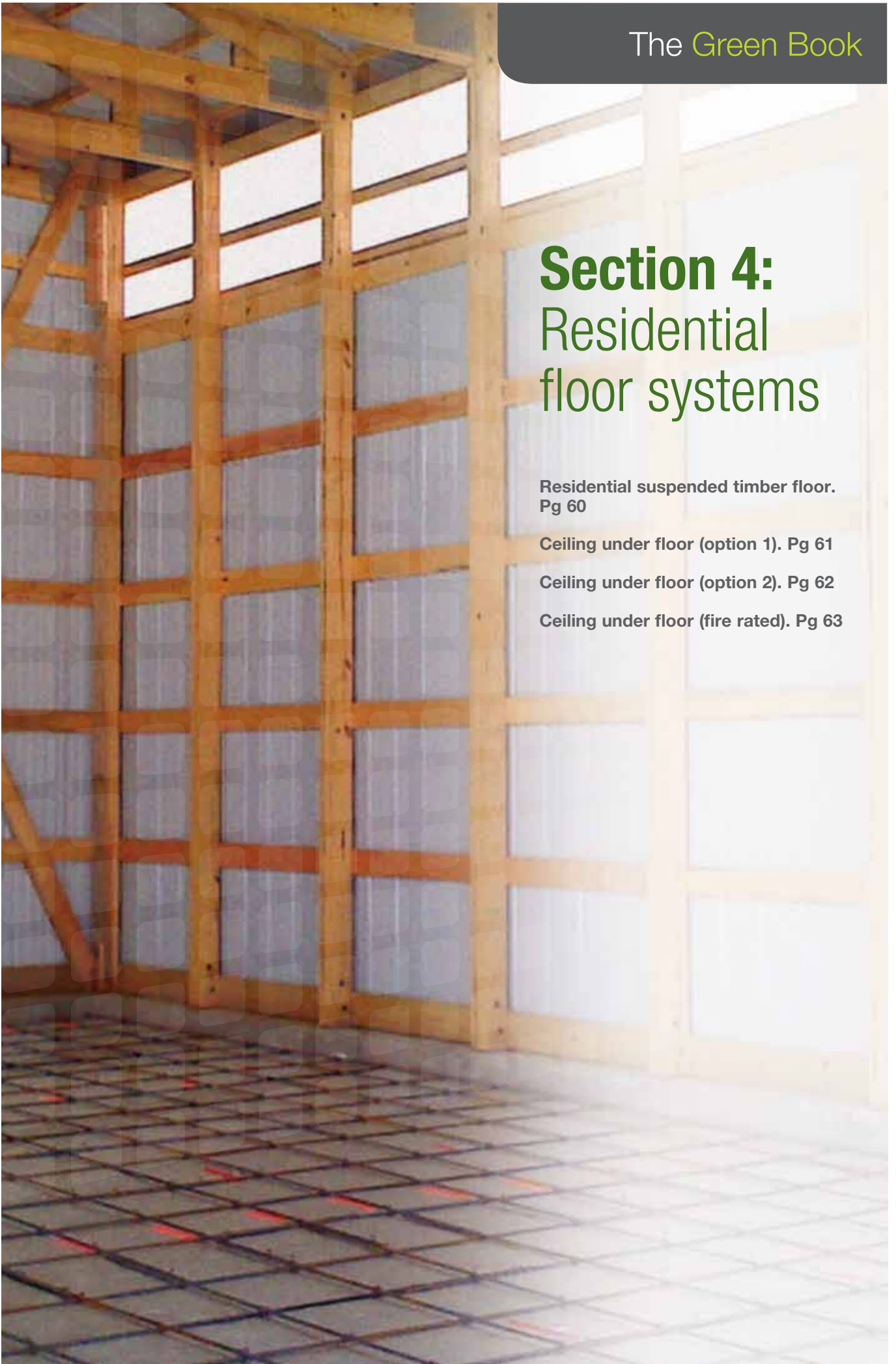

SECTION 4: RESIDENTIAL FLOOR SYSTEMS

RESIDENTIAL SUSPENDED TIMBER FLOOR

STRUCTURE

Timber floor consisting of standard 19mm Tongue and Groove wood composite panels fixed directly over 90mm floor joists. Reflective foil laminate fixed to under side of 90mm joist. Other fixing methods can be adopted ensuring a min. 90mm air cavity is maintained between the floor boards and foil. Bulk insulation placed on perforated foil.

Unventilated floor: Enclosed subfloor perimeter – BCA ventilation rate based on 6000mm²/m. subfloor height based on 0.5m.

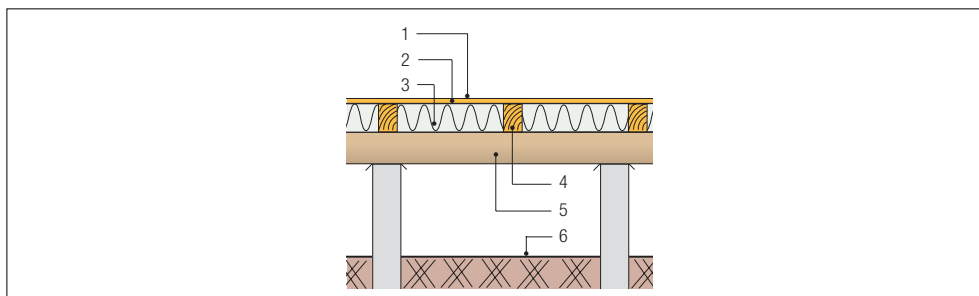

1. Indoor air film
2. 19mm tongue-and-groove timber floor*
3. CosyFloor® insulation
4. 90mm timber floor joist
5. Subfloor reflective air film
6. Ground thermal resistance (RGX)

CAD illustrations: www.insulation.com.au/greenbook

CLIMATE ZONES 1-3 Direction of heat flow = Upward (Summer) for Climate Zones 1 to 2 and 3 Minimum BCA = R1.5 (Climate Zones 1 and 3) Minimum BCA = R1.0 (Climate Zone 2)	PRODUCT VARIATIONS	TOTAL SYSTEM R-VALUES		SOUND REDUCTION INDEX (Rw)	SYSTEM FEATURE
	NON-VENTILATED	WINTER	SUMMER		
	Cosyfloor® R1.5	R2.6	R2.3	30	RE BV EE
VENTILATED	WINTER	SUMMER			
Cosyfloor® R1.5	R1.9	R1.8	30	RE BV EE	

CAD illustrations: www.insulation.com.au/greenbook

CLIMATE ZONES 4, 5, 6, 7 and 8 Direction of heat flow = Downward (Winter) Minimum BCA = R2.75 (Climate Zones 4 and 6) Minimum BCA = R1.0 (Climate Zone 5) Minimum BCA = R2.75 (Climate Zone 7) Minimum BCA = R3.25 (Climate Zone 8: Call 1800 878 for a solution)	PRODUCT VARIATIONS	TOTAL SYSTEM R-VALUES		SOUND REDUCTION INDEX (Rw)	SYSTEM /FEATURE
	NON-VENTILATED	WINTER	SUMMER		
	Cosyfloor® R1.5	R2.6	R2.3	30	RE BV EE
Cosyfloor® R2.0	R3.1	R2.8	30		
VENTILATED	WINTER	SUMMER			
Cosyfloor® R1.5	R2.6	R2.3	30	RE BV EE	
Cosyfloor® R2.0	R2.5	R2.2	30		

* Rw calculation based on Smartfloor Particle Board T&G.

NOTES

- A: Calculations and assumptions in accordance with AS/NZS4859.1:2002 Including Amendment 1: 2006 on the path of insulation as required by BCA Volume 1. Part J and Volume 2. Section 3:12, 2011.
- B. Temperatures and Parameters are based on Australian climate assumptions. Air temperature difference 12°C (36°C less 24°C) for summer conditions and 6°C difference (18°C less 12°C) for winter. Actual conditions may differ from standardised conditions. This will impact on the actual performance of the insulation.
- C. Thermal resistance of air films and attic spaces based on values obtained from Section K5 and K6 of AS/NZS 4859.1: 2002 Including Amendment 1: 2006.
- D. Building material elements based on 2000 AIRAH Handbook and attic thermal value based on AS/NZS4859.1: 2002 Including Amendment 1: 2006 App K6 table K2.
- E. Where reflective insulation is installed, a simple addition of R-values is not possible. Care must be taken to ensure the performance of reflective air spaces is not 'double counted'.
- F. The emittance of the reflective surfaces are dependent on tested values and the conditions of the installation, as specified by AS/NZS4859.1: 2002 Including Amendment 1: 2006.
- G. All Residential roofing calculations in this handbook are based on a dark coloured roof. All Commercial roofing calculations in this handbook are based on a light coloured roof. Please refer to the colour absorbance chart for use of coloured roofs. Also refer to roofing material manufacturer's classification of type of colour for their range. Please contact 1800 000 878 for a customised solution.
- H. The Rw estimate tolerance is ± 3dB.

LEGEND:

- ME** Most Economical
- RE** Recommended
- BV** Best Value
- TB** Thermal Break
- EE** Most Energy Efficient
- RW** Best Sound Reduction
- FA** Fall Arrest

SECTION 4: RESIDENTIAL FLOOR SYSTEMS

CEILING UNDER FLOOR (OPTION 1)

STRUCTURE

Ceiling under floor (in between floor) consisting of 19mm particle board fixed directly over 190mm floor joists. Bulk insulation fitted in between joists with plasterboard ceiling fixed directly beneath joists.

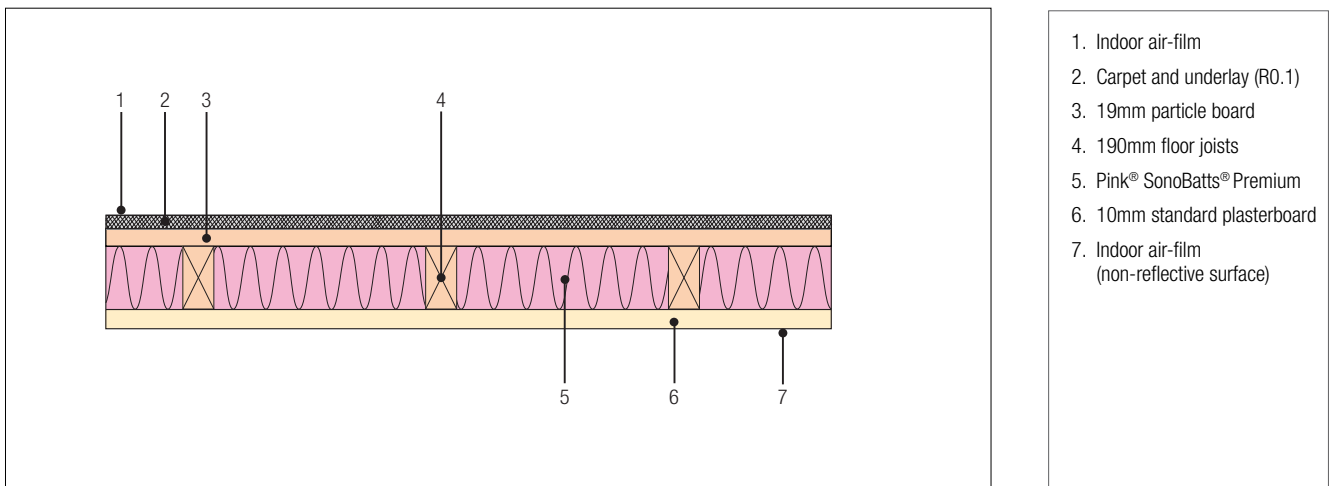

1. Indoor air-film
2. Carpet and underlay (R0.1)
3. 19mm particle board
4. 190mm floor joists
5. Pink® SonoBatts® Premium
6. 10mm standard plasterboard
7. Indoor air-film (non-reflective surface)

CAD illustrations: www.insulation.com.au/greenbook

ALL CLIMATE ZONES No BCA Requirement	PRODUCT VARIATIONS	TOTAL SYSTEM R-VALUES		SOUND REDUCTION INDEX (Rw)	SYSTEM FEATURE
	NON-VENTILATED	WINTER	SUMMER		
	R1.5 50mm Pink® SonoBatts® Premium	R2.2	R1.9	41	ME
	R2.1 70mm Pink® SonoBatts® Premium	R2.8	R2.5	41	
	R2.7 90mm Pink® SonoBatts® Premium	R3.4	R3.1	41	RE BV
	R3.0 100mm Pink® SonoBatts® Premium	R3.7	R3.4	41	RE BV RW

NOTES

- A. Calculations and assumptions in accordance with AS/NZS4859.1:2002 Including Amendment 1: 2006 on the path of insulation as required by BCA Volume 1. Part J and Volume 2. Section 3:12, 2011.
- B. Temperatures and Parameters are based on Australian climate assumptions. Air temperature difference 12°C (36°C less 24°C) for summer conditions and 6°C difference (18°C less 12°C) for winter. Actual conditions may differ from standardised conditions. This will impact on the actual performance of the insulation.
- C. Thermal resistance of air films and attic spaces based on values obtained from Section K5 and K6 of AS/NZS 4859.1: 2002 Including Amendment 1: 2006.
- D. Building material elements based on 2000 AIRAH Handbook and attic thermal value based on AS/NZS4859.1: 2002 Including Amendment 1: 2006 App K6 table K2.
- E. Where reflective insulation is installed, a simple addition of R-values is not possible. Care must be taken to ensure the performance of reflective air spaces is not 'double counted'.
- F. The emittance of the reflective surfaces are dependent on tested values and the conditions of the installation, as specified by AS/NZS4859.1: 2002 Including Amendment 1: 2006.
- G. All Residential roofing calculations in this handbook are based on a dark coloured roof. All Commercial roofing calculations in this handbook are based on a light coloured roof. Please refer to the colour absorbance chart for use of coloured roofs. Also refer to roofing material manufacturer's classification of type of colour for their range. Please contact 1800 000 878 for a customised solution.
- H. The Rw estimate tolerance is ± 3dB.

LEGEND:

- ME** Most Economical
- RE** Recommended
- BV** Best Value
- TB** Thermal Break
- EE** Most Energy Efficient
- RW** Best Sound Reduction
- FA** Fall Arrest

SECTION 4: RESIDENTIAL FLOOR SYSTEMS

CEILING UNDER FLOOR (OPTION 2)

STRUCTURE

Ceiling under floor (in between floor) consisting of 19mm particle board fixed directly over 190mm floor joists. Bulk insulation fitted in between joists with plasterboard ceiling fixed directly beneath joists.

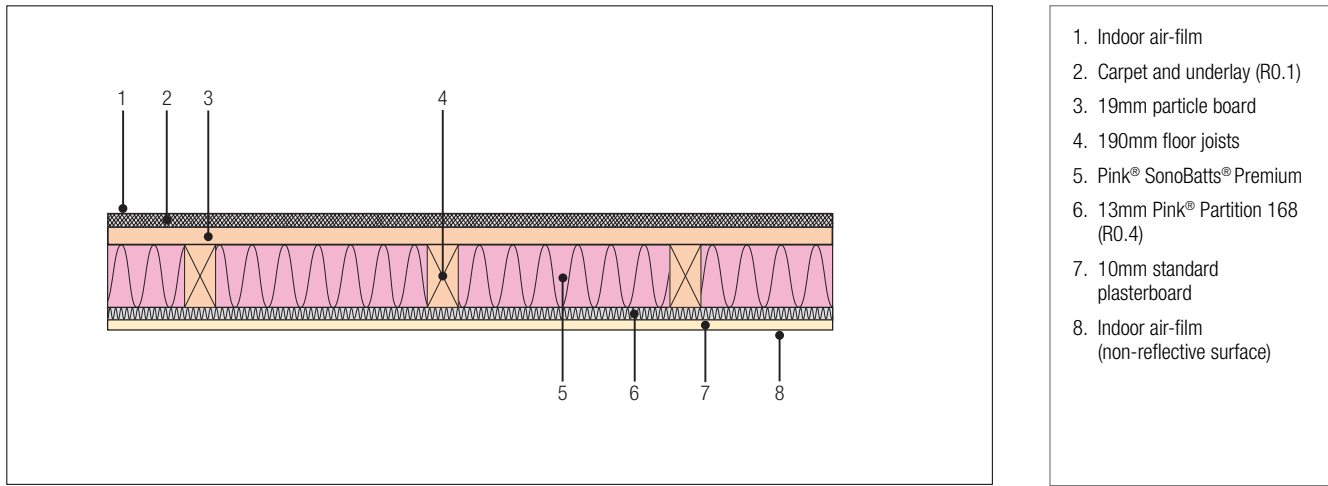

1. Indoor air-film
2. Carpet and underlay (R0.1)
3. 19mm particle board
4. 190mm floor joists
5. Pink® SonoBatts® Premium
6. 13mm Pink® Partition 168 (R0.4)
7. 10mm standard plasterboard
8. Indoor air-film (non-reflective surface)

CAD illustrations: www.insulation.com.au/greenbook

ALL CLIMATE ZONES	PRODUCT VARIATIONS	TOTAL SYSTEM R-VALUES		SOUND REDUCTION INDEX (Rw)	SYSTEM /FEATURE
		WINTER	SUMMER		
No BCA Requirement	NON-VENTILATED				
	R1.5 50mm Pink® SonoBatts® Premium with 13mm Pink® Partition 168*	R2.6	R2.3	49	ME
	R2.1 70mm Pink® SonoBatts® Premium with 13mm Pink® Partition 168*	R3.2	R2.9	49	
	R2.7 90mm Pink® SonoBatts® Premium with 13mm Pink® Partition 168*	R3.8	R3.5	49	RE BV
	R3.0 100mm Pink® SonoBatts® Premium with 13mm Pink® Partition 168*	R4.2	R3.8	49	EE RW

*Ceiling lining fixings through the 13mm Pink® Partition 168 must not be too tight or too frequent.

NOTES

- A: Calculations and assumptions in accordance with AS/NZS4859.1:2002 Including Amendment 1: 2006 on the path of insulation as required by BCA Volume 1. Part J and Volume 2. Section 3:12, 2011.
- B. Temperatures and Parameters are based on Australian climate assumptions. Air temperature difference 12°C (36°C less 24°C) for summer conditions and 6°C difference (18°C less 12°C) for winter. Actual conditions may differ from standardised conditions. This will impact on the actual performance of the insulation.
- C. Thermal resistance of air films and attic spaces based on values obtained from Section K5 and K6 of AS/NZS 4859.1: 2002 Including Amendment 1: 2006.
- D. Building material elements based on 2000 AIRAH Handbook and attic thermal value based on AS/NZS4859.1: 2002 Including Amendment 1: 2006 App K6 table K2.
- E. Where reflective insulation is installed, a simple addition of R-values is not possible. Care must be taken to ensure the performance of reflective air spaces is not 'double counted'.
- F. The emittance of the reflective surfaces are dependent on tested values and the conditions of the installation, as specified by AS/NZS4859.1: 2002 Including Amendment 1: 2006.
- G. All Residential roofing calculations in this handbook are based on a dark coloured roof. All Commercial roofing calculations in this handbook are based on a light coloured roof. Please refer to the colour absorbance chart for use of coloured roofs. Also refer to roofing material manufacturer's classification of type of colour for their range. Please contact 1800 000 878 for a customised solution.
- H. The Rw estimate tolerance is ± 3dB.

- LEGEND:
- ME Most Economical
 - RE Recommended
 - BV Best Value
 - TB Thermal Break
 - EE Most Energy Efficient
 - RW Best Sound Reduction
 - FA Fall Arrest

SECTION 4: RESIDENTIAL FLOOR SYSTEMS

CEILING UNDER FLOOR (FIRE RATED)

STRUCTURE

Ceiling under floor (in between floor) consisting of 19mm particle board fixed directly over 190mm floor joists. Bulk insulation fitted in between joists with fire rated 16mm plasterboard ceiling fixed directly beneath joists.

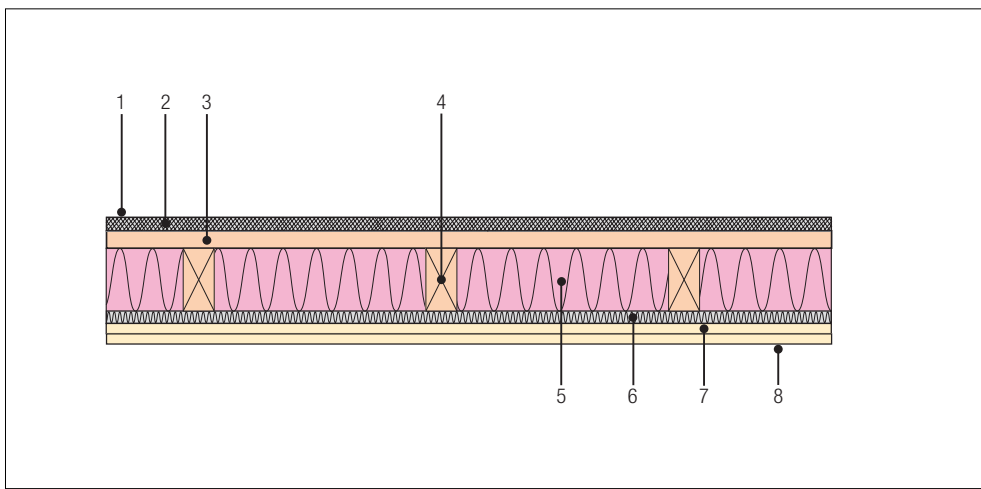

1. Indoor air-film
2. Carpet and underlay (R0.1)
3. 19mm particle board
4. 190mm floor joists
5. Pink® SonoBatts®
6. 13mm Pink® Partition 168 (R0.4)
7. Two layers of 16mm fire rated plasterboard
8. Indoor air-film (non-reflective surface)

CAD illustrations: www.insulation.com.au/greenbook

ALL CLIMATE ZONES No BCA Requirement	PRODUCT VARIATIONS	TOTAL SYSTEM R-VALUES		SOUND REDUCTION INDEX (Rw)	SYSTEM /FEATURE
	NON-VENTILATED	WINTER	SUMMER		
	R1.7 70mm Pink® SonoBatts®	R2.5	R2.3	44	ME
	R2.1 90mm Pink® SonoBatts®	R2.9	R2.7	44	BV
	R1.7 90mm Pink® SonoBatts® with 13mm Pink® Partition 168*	R2.9	R2.7	54	RE
	R2.1 90mm Pink® SonoBatts® with 13mm Pink® Partition 168*	R3.3	R3.0	54	RE, RW

*Ceiling lining fixings through the 13mm Pink® Partition 168 must not be too tight or too frequent.

NOTES

- A: Calculations and assumptions in accordance with AS/NZS4859.1:2002 Including Amendment 1: 2006 on the path of insulation as required by BCA Volume 1. Part J and Volume 2. Section 3:12, 2011.
- B. Temperatures and Parameters are based on Australian climate assumptions. Air temperature difference 12°C (36°C less 24°C) for summer conditions and 6°C difference (18°C less 12°C) for winter. Actual conditions may differ from standardised conditions. This will impact on the actual performance of the insulation.
- C. Thermal resistance of air films and attic spaces based on values obtained from Section K5 and K6 of AS/NZS 4859.1: 2002 Including Amendment 1: 2006.
- D. Building material elements based on 2000 AIRAH Handbook and attic thermal value based on AS/NZS4859.1: 2002 Including Amendment 1: 2006 App K6 table K2.
- E. Where reflective insulation is installed, a simple addition of R-values is not possible. Care must be taken to ensure the performance of reflective air spaces is not 'double counted'.
- F. The emittance of the reflective surfaces are dependent on tested values and the conditions of the installation, as specified by AS/NZS4859.1: 2002 Including Amendment 1: 2006.
- G. All Residential roofing calculations in this handbook are based on a dark coloured roof. All Commercial roofing calculations in this handbook are based on a light coloured roof. Please refer to the colour absorbance chart for use of coloured roofs. Also refer to roofing material manufacturer's classification of type of colour for their range. Please contact 1800 000 878 for a customised solution.
- H. The Rw estimate tolerance is ± 3dB.

- LEGEND:
- ME Most Economical
 - RE Recommended
 - BV Best Value
 - TB Thermal Break
 - EE Most Energy Efficient
 - RW Best Sound Reduction
 - FA Fall Arrest

This page is left blank intentionally

Section 5: Commercial roofing and ceiling systems

Commercial flat metal roof no ceiling (warehouse). Pg 66

Commercial flat metal roof with suspended ceiling plenum return (ventilated). Pg 67

Commercial flat metal roof with suspended ceiling 100mm – 600mm (non ventilated). Pg 68

Commercial flat metal roof with suspended ceiling 600mm – 1200mm (non ventilated plenum). Pg 70

Commercial concrete roof with no ceiling. Pg 72

Commercial concrete suspended slab (car park ceiling below conditioned space). Pg 74

Commercial concrete roof with suspended ceiling 100mm-600mm (non ventilated). Pg 76

Commercial concrete roof with suspended ceiling 600mm-1200mm (non ventilated). Pg 78

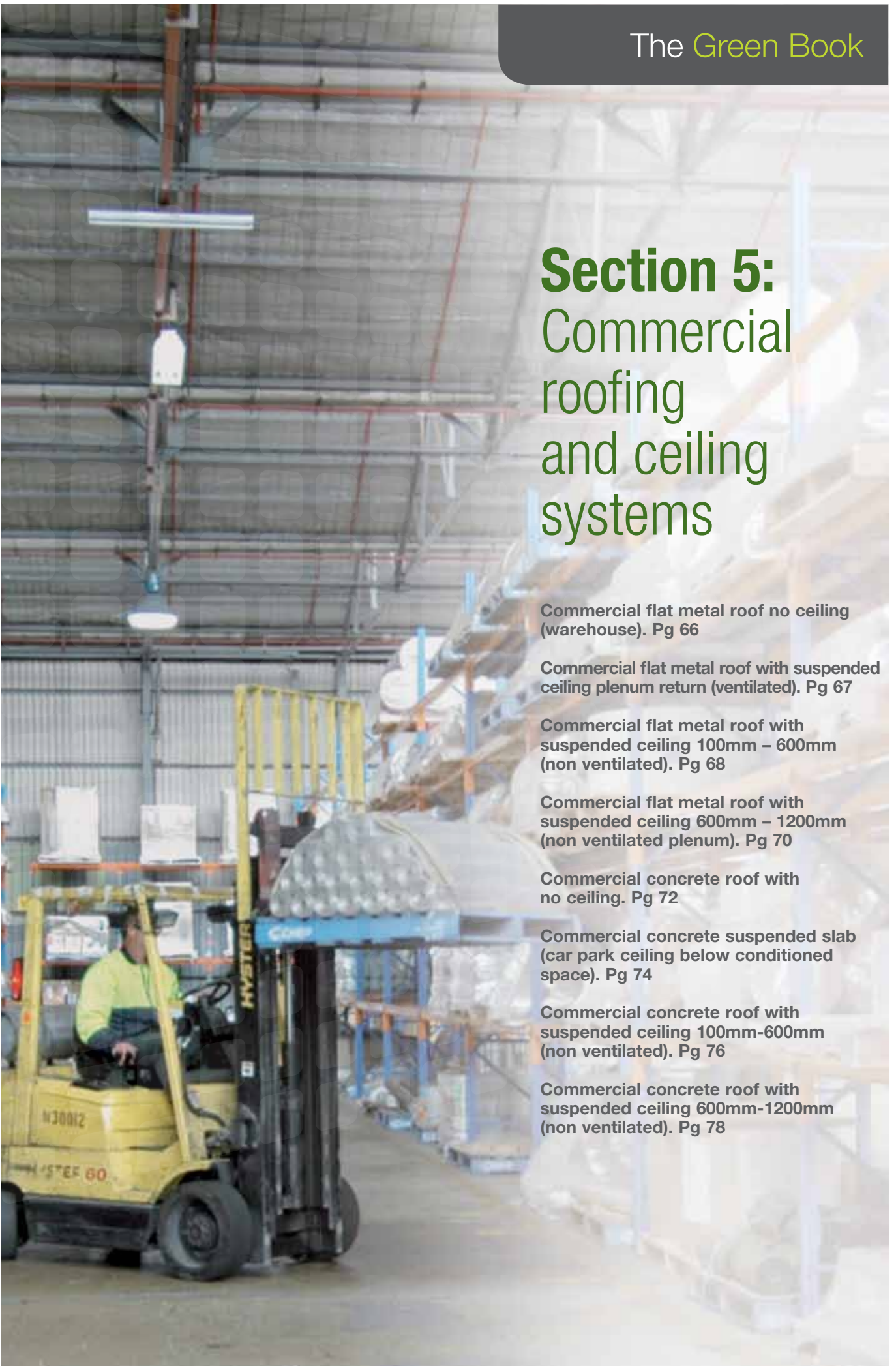

SECTION 5: COMMERCIAL ROOFING AND CEILING SYSTEMS

COMMERCIAL FLAT METAL ROOF NO CEILING (WAREHOUSE)

STRUCTURE

Flat metal roof between 0° to 5° pitch with Roof Rack® spacer to allow Permastop® Building Blanket (installed over safety mesh) to recover to its full nominal thickness.

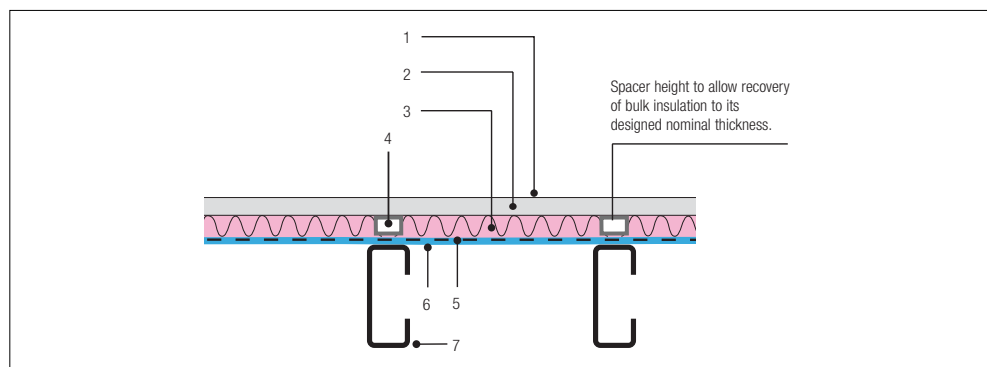

1. Outdoor air-film
2. Metal roof*
3. Permastop® Building Blanket (reflective foil insulation)
4. Roof Rack® insulation spacer
5. Safety mesh
6. Indoor air-film (reflective surface)
7. Purlin

CAD illustrations: www.insulation.com.au/greenbook

CLIMATE ZONES 1 - 6 Direction of heat flow = Downward (summer) Minimum BCA = R3.2	PRODUCT VARIATIONS	TOTAL SYSTEM R-VALUES		SOUND REDUCTION INDEX (Rw)	SYSTEM FEATURE
	VENTILATED	WINTER	SUMMER		
	R3.5 130mm Permastop® and 100mm Roof Rack®	R4.0	R4.1	28	RE EE
	R3.0 130mm Permastop® and 100mm Roof Rack®	R3.4	R3.7	28	RE
	R2.5 100mm Permastop® with 75mm Roof Rack®	R2.9	R3.2	28	ME RE BV
	R3.2 130mm Permastop® (White Faced) and 100mm Roof Rack®	R3.5	R3.1	28	TB
	R3.2 130mm Permastop (Black Faced) and 100mm Roof Rack®	R3.5	R3.1	28	TB

* Required where steel trusses are used

* Rw calculation based on Corrugated 0.48mm BMT metal roof.

CLIMATE ZONES 7 Direction of heat flow = Upward (winter) Minimum BCA = R3.7	PRODUCT VARIATIONS	TOTAL SYSTEM R-VALUES		SOUND REDUCTION INDEX (Rw)	SYSTEM /FEATURE
	VENTILATED	WINTER	SUMMER		
	R3.5 130mm Permastop® and 100mm Roof Rack®	R4.0	R4.1	28	RE BV TB

* Required where steel trusses are used

* Rw calculation based on Corrugated 0.48mm BMT metal roof.

CLIMATE ZONES 8 Direction of heat flow = Upward (winter) Minimum BCA = R4.8	PRODUCT VARIATIONS	TOTAL SYSTEM R-VALUES		SOUND REDUCTION INDEX (Rw)	SYSTEM FEATURE
	VENTILATED	WINTER	SUMMER		
	Call 1800 000 878 for a solution				

NOTES

- A: Calculations and assumptions in accordance with AS/NZS4859.1:2002 Including Amendment 1: 2006 on the path of insulation as required by BCA Volume 1. Part J and Volume 2. Section 3:12, 2011.
- B: Temperatures and Parameters are based on Australian climate assumptions. Air temperature difference 12°C (36°C less 24°C) for summer conditions and 6°C difference (18°C less 12°C) for winter. Actual conditions may differ from standardised conditions. This will impact on the actual performance of the insulation.
- C: Thermal resistance of air films and attic spaces based on values obtained from Section K5 and K6 of AS/NZS 4859.1: 2002 Including Amendment 1: 2006.
- D: Building material elements based on 2000 AIRAH Handbook and attic thermal value based on AS/NZS4859.1: 2002 Including Amendment 1: 2006 App K6 table K2.
- E: Where reflective insulation is installed, a simple addition of R-values is not possible. Care must be taken to ensure the performance of reflective air spaces is not 'double counted'.
- F: The emittance of the reflective surfaces are dependent on tested values and the conditions of the installation, as specified by AS/NZS4859.1: 2002 Including Amendment 1: 2006.
- G: All Residential roofing calculations in this handbook are based on a dark coloured roof. All Commercial roofing calculations in this handbook are based on a light coloured roof. Please refer to the colour absorbance chart for use of coloured roofs. Also refer to roofing material manufacturer's classification of type of colour for their range. Please contact 1800 000 878 for a customised solution.
- H: The Rw estimate tolerance is ± 3dB.

LEGEND:

- ME** Most Economical
- RE** Recommended
- BV** Best Value
- TB** Thermal Break
- EE** Most Energy Efficient
- RW** Best Sound Reduction
- FA** Fall Arrest

SECTION 5: COMMERCIAL ROOFING AND CEILING SYSTEMS

COMMERCIAL FLAT METAL ROOF WITH SUSPENDED CEILING PLENUM RETURN (VENTILATED)

STRUCTURE

Flat metal roof between 0° to 5° pitch with Roof Rack® spacer over Permastop® Building Blanket (reflective foil insulation) over safety mesh. 100-600mm ceiling void used as a return air plenum. Optional Pink Batts® ceiling insulation, 100mm plasterboard ceiling fixed to the suspended ceiling grid.

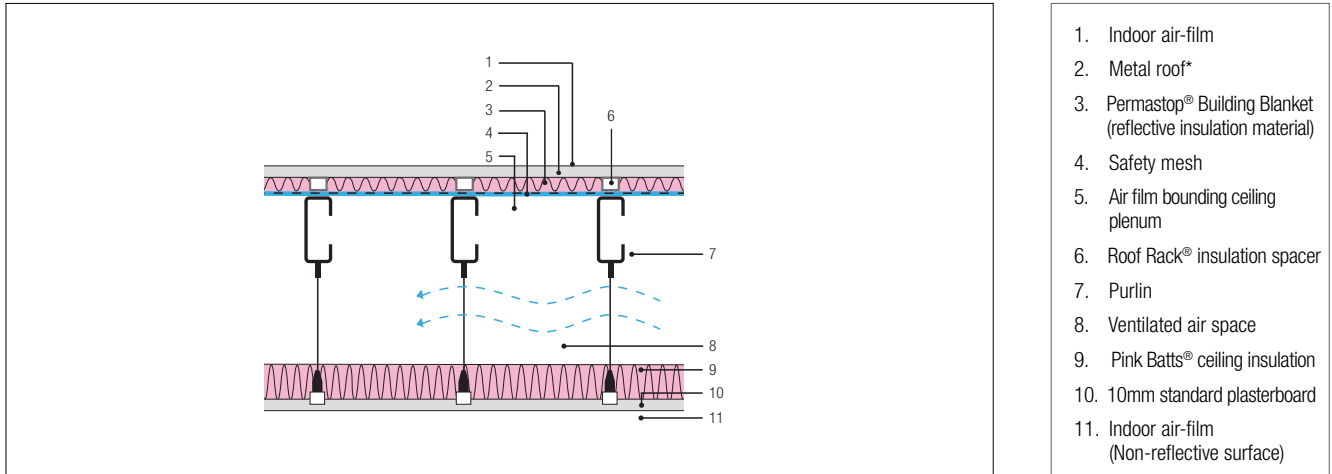

CAD illustrations: www.insulation.com.au/greenbook

CLIMATE ZONES 1 - 6 Direction of heat flow = Downward (summer) Minimum BCA = R3.2	PRODUCT VARIATIONS	TOTAL SYSTEM R-VALUES		SOUND REDUCTION INDEX (Rw)		SYSTEM FEATURE
	VENTILATED	WINTER	SUMMER	100mm	600mm	
	R3.5 130mm Permastop and 100mm Roof Rack	R3.8	R3.5	42	45	

CLIMATE ZONES 7 Direction of heat flow = Upward (winter) Minimum BCA = R3.7	PRODUCT VARIATIONS	TOTAL SYSTEM R-VALUES		SOUND REDUCTION INDEX (Rw)		SYSTEM FEATURE
	VENTILATED	WINTER	SUMMER	100mm	600mm	
	R3.5 130mm Permastop and 100mm Roof Rack Roof	R3.8	R3.5	42	45	

^ Required where steel trusses are used

* Rw calculation based on Corrugated 0.48mm BMT metal roof.

CLIMATE ZONES 8 Direction of heat flow = Upward (winter) Minimum BCA = R4.8	PRODUCT VARIATIONS	TOTAL SYSTEM R-VALUES		SOUND REDUCTION INDEX (Rw)		SYSTEM FEATURE
	VENTILATED	WINTER	SUMMER			
	Return Air Plenum should not be used in this zone					

NOTES

A: Calculations and assumptions in accordance with AS/NZS4859.1:2002 Including Amendment 1: 2006 on the path of insulation as required by BCA Volume 1. Part J and Volume 2. Section 3:12, 2011.

B. Temperatures and Parameters are based on Australian climate assumptions. Air temperature difference 12°C (36°C less 24°C) for summer conditions and 6°C difference (18°C less 12°C) for winter. Actual conditions may differ from standardised conditions. This will impact on the actual performance of the insulation.

C. Thermal resistance of air films and attic spaces based on values obtained from Section K5 and K6 of AS/NZS 4859.1: 2002 Including Amendment 1: 2006.

D. Building material elements based on 2000 AIRAH Handbook and attic thermal value based on AS/NZS4859.1: 2002 Including Amendment 1: 2006 App K6 table K2.

E. Where reflective insulation is installed, a simple addition of R-values is not possible. Care must be taken to ensure the performance of reflective air spaces is not 'double counted'.

F. The emittance of the reflective surfaces are dependent on tested values and the conditions of the installation, as specified by AS/NZS4859.1: 2002 Including Amendment 1: 2006.

G. All Residential roofing calculations in this handbook are based on a dark coloured roof. All Commercial roofing calculations in this handbook are based on a light coloured roof. Please refer to the colour absorbance chart for use of coloured roofs. Also refer to roofing material manufacturer's classification of type of colour for their range. Please contact 1800 000 878 for a customised solution.

H. The Rw estimate tolerance is ± 3dB.

LEGEND:

- Most Economical
- Recommended
- Best Value
- Thermal Break
- Most Energy Efficient
- Best Sound Reduction
- Fall Arrest

SECTION 5: COMMERCIAL ROOFING AND CEILING SYSTEMS

COMMERCIAL FLAT METAL ROOF WITH SUSPENDED CEILING 100mm – 600mm (NON VENTILATED)

STRUCTURE

Flat metal roof between 0° to 5° pitch with Roof Rack® insulation spacer over Permastop® Building Blanket (reflective foil insulation) over safety mesh. 100-600mm ceiling void. Optional Pink Batts® ceiling insulation, 100mm plasterboard ceiling fixed to the suspended ceiling grid.

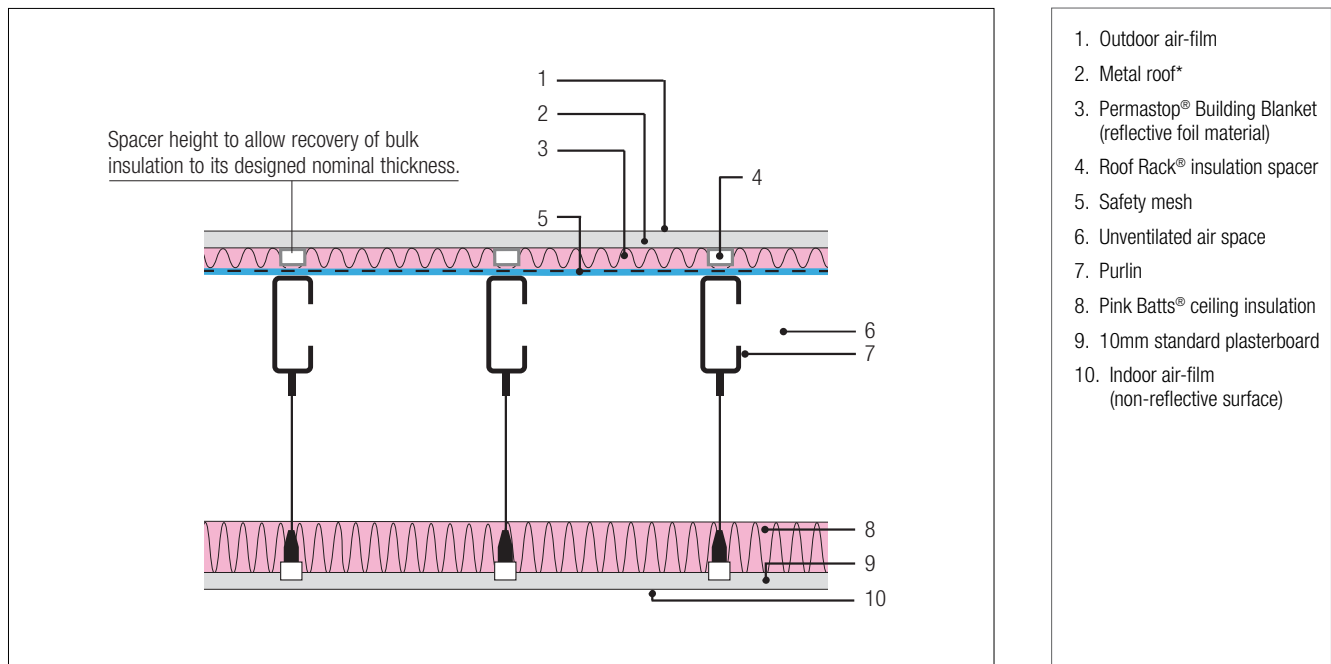

CAD illustrations: www.insulation.com.au/greenbook

CLIMATE ZONES 1 - 6 Direction of heat flow = Downward (summer) Minimum BCA = R3.2	PRODUCT VARIATIONS	TOTAL SYSTEM R-VALUES		SOUND REDUCTION INDEX (R _w)		SYSTEM FEATURE
	NON-VENTILATED	WINTER	SUMMER	100mm	600mm	
	R1.8 75mm Permastop® with 75mm Roof Rack®	R2.7	R3.7	39	43	ME TB
	R2.5 with 100mm Permastop® with 75mm Roof Rack®	R3.4	R4.4	39	43	RE BV TB
	R3.0 with 130mm Permastop® with 100mm Roof Rack®	R4.0	R4.8	41	45	TB
	R3.2 with 130mm Permastop® with 100mm Roof Rack®	R4.2	R5.0	41	45	TB EE

CLIMATE ZONES 7 Direction of heat flow = Upward (winter) Minimum BCA = R3.7	PRODUCT VARIATIONS	TOTAL SYSTEM R-VALUES		SOUND REDUCTION INDEX (R _w)		SYSTEM FEATURE
	NON-VENTILATED	WINTER	SUMMER	100mm	600mm	
	R3.0 130mm Permastop® with 100mm Roof Rack®	R4.0	R4.8	41	45	RE BV TB
	R3.2 130mm Permastop® with 100mm Roof Rack®	R4.2	R5.0	41	45	TB
	R1.8 with 75mm Permastop® with 75mm Roof Rack® and R1.5 Pink Ceiling Batts®	R4.3	R5.2	41	45	TB EE

CLIMATE ZONE 8 Direction of heat flow = Upward (winter) Minimum BCA = R4.8	PRODUCT VARIATIONS	TOTAL SYSTEM R-VALUES		SOUND REDUCTION INDEX (R _w)		SYSTEM FEATURE
	NON-VENTILATED	WINTER	SUMMER	100mm	600mm	
	R1.8 75mm Permastop® with 75mm Roof Rack and R2.0 Pink Ceiling Batts®	R4.8	R5.7	41	45	TB
	R2.5 100mm Permastop® with 75mm Roof Rack® and R1.5 Pink Ceiling Batts®	R5.1	R5.9	41	45	RE TB EE

* R_w calculation based on Corrugated 0.48mm BMT metal roof.

NOTES

- Calculations and assumptions in accordance with AS/NZS4859.1:2002 Including Amendment 1: 2006 on the path of insulation as required by BCA Volume 1. Part J and Volume 2. Section 3:12, 2011.
- Temperatures and Parameters are based on Australian climate assumptions. Air temperature difference 12°C (36°C less 24°C) for summer conditions and 6°C difference (18°C less 12°C) for winter. Actual conditions may differ from standardised conditions. This will impact on the actual performance of the insulation.
- Thermal resistance of air films and attic spaces based on values obtained from Section K5 and K6 of AS/NZS 4859.1: 2002 Including Amendment 1: 2006.
- Building material elements based on 2000 AIRAH Handbook and attic thermal value based on AS/NZS4859.1: 2002 Including Amendment 1: 2006 App K6 table K2.
- Where reflective insulation is installed, a simple addition of R-values is not possible. Care must be taken to ensure the performance of reflective air spaces is not 'double counted'.
- The emittance of the reflective surfaces are dependent on tested values and the conditions of the installation, as specified by AS/NZS4859.1: 2002 Including Amendment 1: 2006.
- All Residential roofing calculations in this handbook are based on a dark coloured roof. All Commercial roofing calculations in this handbook are based on a light coloured roof. Please refer to the colour absorbance chart for use of coloured roofs. Also refer to roofing material manufacturer's classification of type of colour for their range. Please contact 1800 000 878 for a customised solution.
- The R_w estimate tolerance is ± 3dB.

LEGEND:

- ME** Most Economical
- RE** Recommended
- BV** Best Value
- TB** Thermal Break
- EE** Most Energy Efficient
- RW** Best Sound Reduction
- FA** Fall Arrest

SECTION 5: COMMERCIAL ROOFING AND CEILING SYSTEMS

COMMERCIAL FLAT METAL ROOF WITH SUSPENDED CEILING 600mm – 1200mm (NON VENTILATED PLENUM)

STRUCTURE

Flat metal roof between 0° to 5° pitch with Roof Rack® insulation spacer over Permastop® Building Blanket (reflective foil insulation) over safety mesh. 600-1200mm ceiling void. Optional Pink Batts® ceiling insulation, 100mm plasterboard ceiling fixed to the suspended ceiling grid.

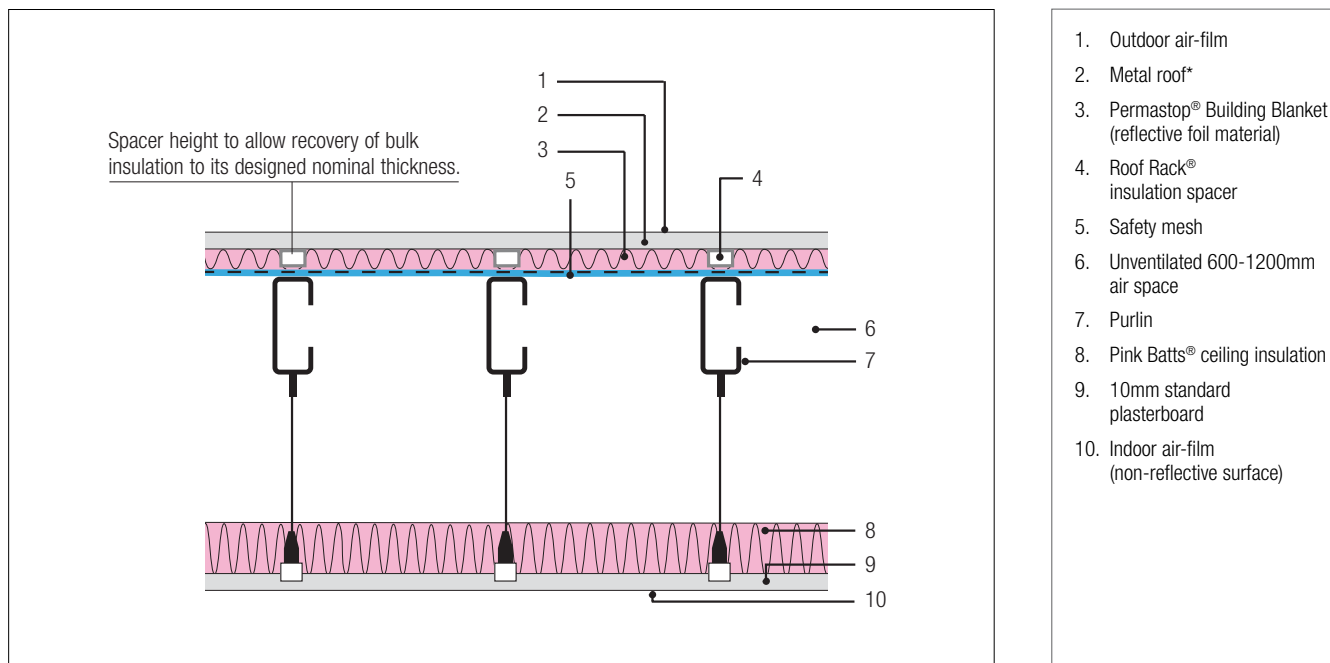

CAD illustrations: www.insulation.com.au/greenbook

CLIMATE ZONES 1 - 6 Direction of heat flow = downward (summer) Minimum BCA = R3.2	PRODUCT VARIATIONS	TOTAL SYSTEM R-VALUES		SOUND REDUCTION INDEX (Rw)		SYSTEM FEATURE
	NON-VENTILATED	WINTER	SUMMER	600mm	1200mm	
	R1.8 75mm Permastop® with 75mm Roof Rack®	R2.6	R4.8	43	43	
	R2.5 100mm Permastop® with 75mm Roof Rack®	R3.3	R5.5	43	43	
	R3.0 130mm Permastop® with 100mm Roof Rack®	R3.8	R6.0	45	45	
	R3.2 130mm Permastop® with 100mm Roof Rack®	R4.1	R6.2	45	45	

CLIMATE ZONES 7 Direction of heat flow = upward (winter) Minimum BCA = R3.7	PRODUCT VARIATIONS	TOTAL SYSTEM R-VALUES		SOUND REDUCTION INDEX (Rw)		SYSTEM FEATURE
	NON-VENTILATED	WINTER	SUMMER	600mm	1200mm	
	R3.0 130mm Permastop® with 100mm Roof Rack®	R3.8	R6.0	45	45	
	R3.2 130mm Permastop® with 100mm Roof Rack®	R4.1	R6.2	45	45	
	R1.8 75mm Permastop® with 75mm Roof Rack® and R1.5 Pink Batts	R4.2	R6.3	45	45	

CLIMATE ZONES 8 Direction of heat flow = upward (winter) Minimum BCA = R4.8	PRODUCT VARIATIONS	TOTAL SYSTEM R-VALUES		SOUND REDUCTION INDEX (Rw)		SYSTEM FEATURE
	NON-VENTILATED	WINTER	SUMMER	600mm	1200mm	
	R2.5 100mm Permastop® with 75mm Roof Rack® and R2.0 Pink Batts®	R5.4	R7.5	45	45	
	R3.0 130mm Permastop® with 100mm Roof Rack® and R1.5 Pink Batts®	R5.4	R7.5	45	45	

^ Required where steel trusses are used

* Rw calculation based on Corrugated 0.48mm BMT metal roof.

NOTES

A. Calculations and assumptions in accordance with AS/NZS4859.1:2002 Including Amendment 1: 2006 on the path of insulation as required by BCA Volume 1. Part J and Volume 2. Section 3:12, 2011.

B. Temperatures and Parameters are based on Australian climate assumptions. Air temperature difference 12°C (36°C less 24°C) for summer conditions and 6°C difference (18°C less 12°C) for winter. Actual conditions may differ from standardised conditions. This will impact on the actual performance of the insulation.

C. Thermal resistance of air films and attic spaces based on values obtained from Section K5 and K6 of AS/NZS 4859.1: 2002 Including Amendment 1: 2006.

D. Building material elements based on 2000 AIRAH Handbook and attic thermal value based on AS/NZS4859.1: 2002 Including Amendment 1: 2006 App K6 table K2.

E. Where reflective insulation is installed, a simple addition of R-values is not possible. Care must be taken to ensure the performance of reflective air spaces is not 'double counted'.

F. The emittance of the reflective surfaces are dependent on tested values and the conditions of the installation, as specified by AS/NZS4859.1: 2002 Including Amendment 1: 2006.

G. All Residential roofing calculations in this handbook are based on a dark coloured roof. All Commercial roofing calculations in this handbook are based on a light coloured roof. Please refer to the colour absorbance chart for use of coloured roofs. Also refer to roofing material manufacturer's classification of type of colour for their range. Please contact 1800 000 878 for a customised solution.

H. The Rw estimate tolerance is ± 3dB.

I. Thermal resistance contribution of the unventilated ceiling plenum is determined for a thickness of 600mm (a conservative estimate for thickness up to 1200mm) in accordance with ISO6946: 2007 where the width and length dimensions of the airspace are greater than 10 times its thickness, and the area of any openings does not exceed 500mm² per square metre of surface area.

LEGEND:

- Most Economical
- Recommended
- Best Value
- Thermal Break
- Most Energy Efficient
- Best Sound Reduction
- Fall Arrest

SECTION 5: COMMERCIAL ROOFING AND CEILING SYSTEMS

COMMERCIAL CONCRETE ROOF WITH NO CEILING

STRUCTURE

150mm concrete slab with exterior waterproofing membrane. Reflective insulation fixed below slab.

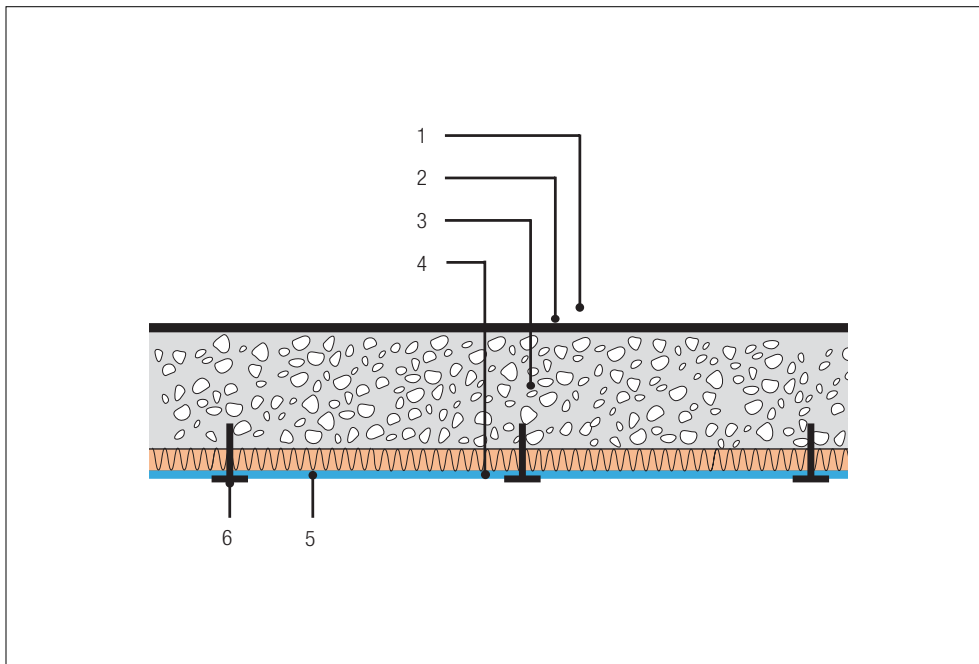

1. Outdoor air film
2. Exterior waterproofing membrane (R0.061)
3. 150mm concrete slab
4. Pink® Thermal Slab HD (Reflective insulation Material)
5. Indoor air-film (reflective surface)
6. Suitable fixing system (mechanically fixed to slab)*

* Ensuring insulation product maintains its nominal thickness.

CAD illustrations: www.insulation.com.au/greenbook

CLIMATE ZONES 1 - 6 Direction of heat flow = downward (summer) Minimum BCA = R3.2	PRODUCT VARIATIONS	TOTAL SYSTEM R-VALUES		SOUND REDUCTION INDEX (R _w) ¹	SYSTEM FEATURE
	NON-VENTILATED	WINTER	SUMMER		
	R3.0 100mm Pink® Thermal Slab HD foil faced	R3.6	R3.9	65	RE EE
	R2.5 100mm Permastop® HD foil faced	R3.1	R3.4	57	FA

CLIMATE ZONE 7 Direction of heat flow = upward (winter) Minimum BCA = R3.7	PRODUCT VARIATIONS	TOTAL SYSTEM R-VALUES		SOUND REDUCTION INDEX (R _w)	SYSTEM FEATURE
	NON-VENTILATED	WINTER	SUMMER		
	R3.0 100mm Pink® Thermal Slab HD foil faced	R3.6	R3.9	65	RE EE
	R3.2 130mm Permastop® HD foil faced	R3.8	R4.1	57	FA EE

CLIMATE ZONE 8 Direction of heat flow = upward (winter) Minimum BCA = R4.8	PRODUCT VARIATIONS	TOTAL SYSTEM R-VALUES		SOUND REDUCTION INDEX (R _w)	SYSTEM FEATURE
	NON-VENTILATED	WINTER	SUMMER		
	Call 1800 000 878 for a solution				

1. Special measures to reduce flanking would be required to achieve the potential performance of these constructions outside of the laboratory.

NOTES

- A: Calculations and assumptions in accordance with AS/NZS4859.1:2002 Including Amendment 1: 2006 on the path of insulation as required by BCA Volume 1. Part J and Volume 2. Section 3:12, 2011.
- B. Temperatures and Parameters are based on Australian climate assumptions. Air temperature difference 12°C (36°C less 24°C) for summer conditions and 6°C difference (18°C less 12°C) for winter. Actual conditions may differ from standardised conditions. This will impact on the actual performance of the insulation.
- C. Thermal resistance of air films and attic spaces based on values obtained from Section K5 and K6 of AS/NZS 4859.1: 2002 Including Amendment 1: 2006.
- D. Building material elements based on 2000 AIRAH Handbook and attic thermal value based on AS/NZS4859.1: 2002 Including Amendment 1: 2006 App K6 table K2.
- E. Where reflective insulation is installed, a simple addition of R-values is not possible. Care must be taken to ensure the performance of reflective air spaces is not 'double counted'.
- F. The emittance of the reflective surfaces are dependent on tested values and the conditions of the installation, as specified by AS/NZS4859.1: 2002 Including Amendment 1: 2006.
- G. All Residential roofing calculations in this handbook are based on a dark coloured roof. All Commercial roofing calculations in this handbook are based on a light coloured roof. Please refer to the colour absorbance chart for use of coloured roofs. Also refer to roofing material manufacturer's classification of type of colour for their range. Please contact 1800 000 878 for a customised solution.
- H. The R_w estimate tolerance is ± 3dB.

LEGEND:

- ME Most Economical
- RE Recommended
- BV Best Value
- TB Thermal Break
- EE Most Energy Efficient
- RW Best Sound Reduction
- FA Fall Arrest

SECTION 5: COMMERCIAL ROOFING AND CEILING SYSTEMS

COMMERCIAL CONCRETE SUSPENDED SLAB (CAR PARK CEILING BELOW CONDITIONED SPACE)

STRUCTURE

150mm concrete suspended floor slab, no floor covering. Pink® Thermal Slab pinned to underside of slab, reflective facing foil layer facing downwards. Ground below.

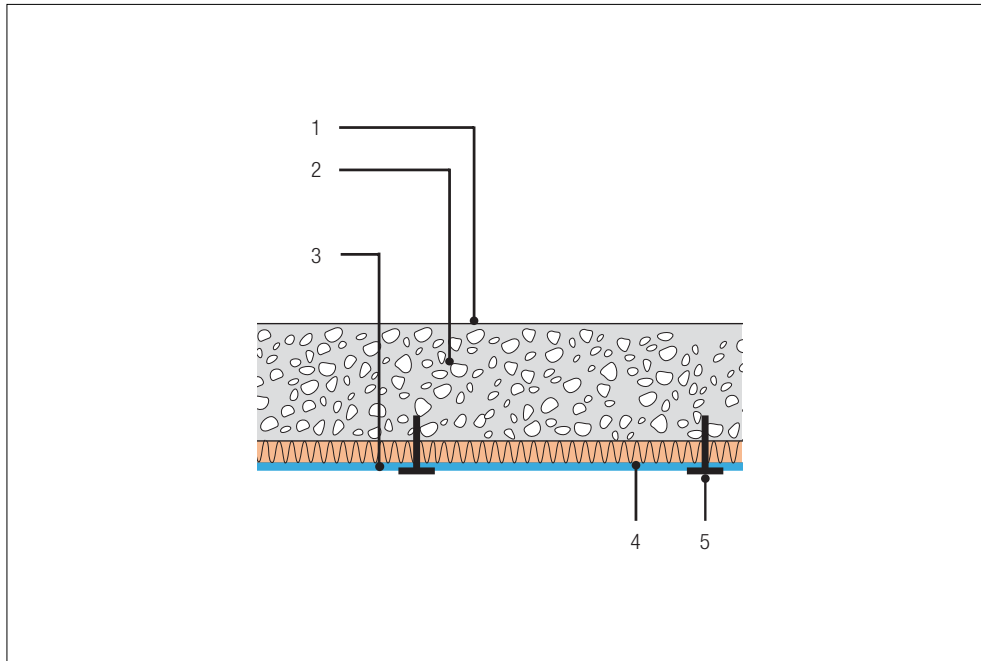

1. Indoor air-film
2. 150mm concrete slab
3. Pink® Thermal Slab HD (Reflective insulation Material)
4. Unventilated/ventilated subfloor reflective/non-reflective air film
5. Suitable fixing system (mechanically fixed to slab)*

* Ensuring insulation product maintains its nominal thickness.

CAD illustrations: www.insulation.com.au/greenbook

CLIMATE ZONES 1 - 6 Direction of heat flow = downward (summer) Minimum BCA = R3.2	PRODUCT VARIATIONS	TOTAL SYSTEM R-VALUES		SOUND REDUCTION INDEX (Rw) ¹	SYSTEM FEATURE
	VENTILATED	WINTER	SUMMER		
	R2.3 75mm Pink® Thermal Slab HD foil faced	R2.7	R2.6	65	RE BV EE
R2.3 75mm Pink® Thermal Slab HD White	R2.7	R2.6	65		
UNVENTILATED (ENCLOSED PERIMETER)					
R2.3 75mm Pink® Thermal Slab HD foil faced	R4.0	R3.3	65	RE BV EE	
R2.3 75mm Pink® Thermal Slab HD White	R3.4	R3.2	65		

CLIMATE ZONE 7 Direction of heat flow = upward (winter) Minimum BCA = R3.7	PRODUCT VARIATIONS	TOTAL SYSTEM R-VALUES		SOUND REDUCTION INDEX (Rw)	SYSTEM FEATURE
	VENTILATED	WINTER	SUMMER		
	R2.3 75mm Pink® Thermal Slab HD foil faced	R2.7	R2.6	65	RE BV EE
R2.3 75mm Pink® Thermal Slab HD White	R2.7	R2.6	65		
UNVENTILATED (ENCLOSED PERIMETER)					
R3.0 100mm Pink® Thermal Slab HD foil faced	R4.8	R4.0	65	RE BV EE	
R3.0 100mm Pink® Thermal Slab HD White	R4.1	R3.8	65		

CLIMATE ZONE 8 Direction of heat flow = upward (winter) Minimum BCA = R4.8	PRODUCT VARIATIONS	TOTAL SYSTEM R-VALUES		SOUND REDUCTION INDEX (Rw)	SYSTEM FEATURE
	UNVENTILATED (ENCLOSED PERIMETER)	WINTER	SUMMER		
	R3.0 100mm Pink® Thermal Slab HD foil faced	R4.8	R4.0	65	RE BV EE

1. Special measures to reduce flanking would be required to achieve the potential performance of these constructions outside of the laboratory.

NOTES

- A: Calculations and assumptions in accordance with AS/NZS4859.1:2002 Including Amendment 1: 2006 on the path of insulation as required by BCA Volume 1. Part J and Volume 2. Section 3:12, 2011.
- B. Temperatures and Parameters are based on Australian climate assumptions. Air temperature difference 12°C (36°C less 24°C) for summer conditions and 6°C difference (18°C less 12°C) for winter. Actual conditions may differ from standardised conditions. This will impact on the actual performance of the insulation.
- C. Thermal resistance of air films and attic spaces based on values obtained from Section K5 and K6 of AS/NZS 4859.1: 2002 Including Amendment 1: 2006.
- D. Building material elements based on 2000 AIRAH Handbook and attic thermal value based on AS/NZS4859.1: 2002 Including Amendment 1: 2006 App K6 table K2.
- E. Where reflective insulation is installed, a simple addition of R-values is not possible. Care must be taken to ensure the performance of reflective air spaces is not 'double counted'.
- F. The emittance of the reflective surfaces are dependent on tested values and the conditions of the installation, as specified by AS/NZS4859.1: 2002 Including Amendment 1: 2006.
- G. All Residential roofing calculations in this handbook are based on a dark coloured roof. All Commercial roofing calculations in this handbook are based on a light coloured roof. Please refer to the colour absorbance chart for use of coloured roofs. Also refer to roofing material manufacturer's classification of type of colour for their range. Please contact 1800 000 878 for a customised solution.
- H. The Rw estimate tolerance is ± 3dB.

- LEGEND:
- ME Most Economical
 - RE Recommended
 - BV Best Value
 - TB Thermal Break
 - EE Most Energy Efficient
 - RW Best Sound Reduction
 - FA Fall Arrest

SECTION 5: COMMERCIAL ROOFING AND CEILING SYSTEMS

COMMERCIAL CONCRETE ROOF WITH SUSPENDED CEILING 100mm-600mm (NON VENTILATED)

STRUCTURE

150mm concrete suspended floor slab with exterior waterproofing membrane. Reflective Insulation fixed below slab. 600mm airspace below slab with 10mm plasterboard fixed to suspended ceiling.

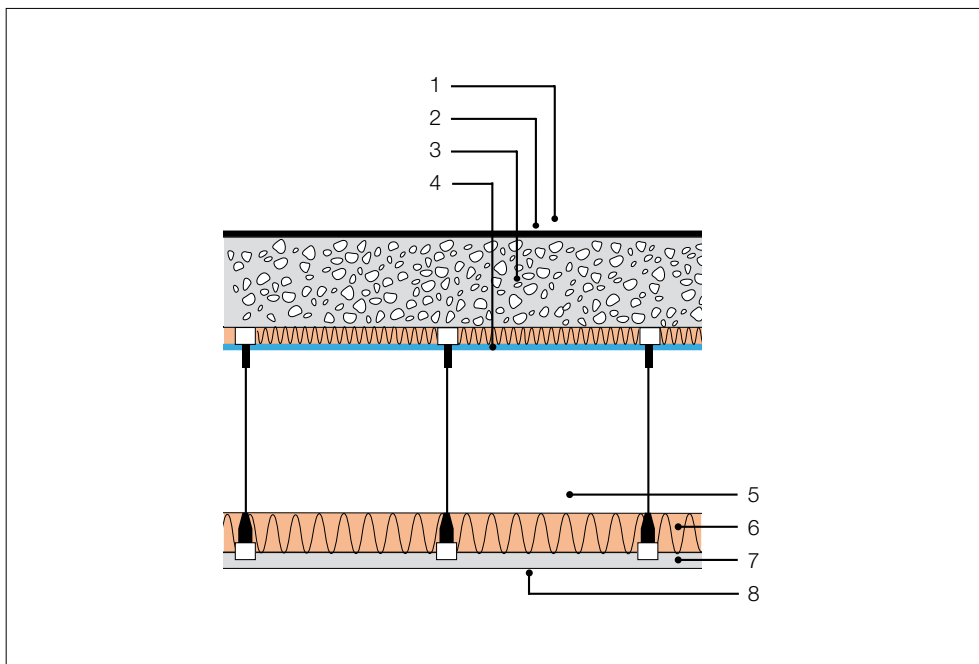

1. Indoor air-film
2. Roof waterproofing membrane
3. 150mm concrete slab
4. Pink® Thermal Slab HD (Reflective insulation Material)
5. Unventilated air space (100mm-600mm)
6. Pink® Building Blanket
7. 10mm standard plasterboard
8. Indoor air-film (non reflective surface)

CAD illustrations: www.insulation.com.au/greenbook

CLIMATE ZONES 1 - 6 Direction of heat flow = Downward (Summer) Minimum BCA = R3.2	PRODUCT VARIATIONS	TOTAL SYSTEM R-VALUES		SOUND REDUCTION INDEX (Rw) ¹		SYSTEM FEATURE
	NON-VENTILATED	WINTER	SUMMER	100mm	600mm	
	R1.5 50mm Pink® Thermal Slab HD foil faced	R2.5	R3.6	69	72	RE
	R1.3 55mm Permastop® with Heavy Duty Sisalation®	R2.3	R3.4	69	72	RE
	R1.8 75mm Permastop® with Heavy Duty Sisalation®	R2.8	R3.9	69	72	BV
	R2.5 100mm Permastop® with Heavy Duty Sisalation®	R3.6	R4.6	69	72	
	R1.3 55mm Permastop® with R1.3 55mm Pink® Building Blanket on ceiling	R3.7	R4.8	69	72	EE

CLIMATE ZONES 7 Direction of heat flow = Upward (Winter) Minimum BCA = R3.7	PRODUCT VARIATIONS	TOTAL SYSTEM R-VALUES		SOUND REDUCTION INDEX (Rw)		SYSTEM FEATURE
	NON-VENTILATED	WINTER	SUMMER	100mm	600mm	
	R3.0 100mm Pink® Thermal Slab HD foil faced	R4.1	R5.0	69	72	RE EE
	R3.0 130mm Permastop® with Heavy Duty Sisalation® on ceiling	R4.1	R5.0	69	72	BV EE
	R1.3 55mm Permastop® with R1.3 55mm Pink® Building Blanket on ceiling	R3.7	R4.8	69	72	RE

CLIMATE ZONES 8 Direction of heat flow = Upward (Winter) Minimum BCA = R4.8	PRODUCT VARIATIONS	TOTAL SYSTEM R-VALUES		SOUND REDUCTION INDEX (Rw)		SYSTEM FEATURE
	NON-VENTILATED	WINTER	SUMMER	100mm	600mm	
	R1.5 50mm Pink® Thermal Slab HD foil faced and R2.5 Pink® Building Blanket on ceiling	R5.2	R6.1	69	72	RE
	R1.3 55mm Permastop® with R2.5 100mm Pink® Building Blanket on ceiling	R5.0	R5.9	69	72	BV
	R3.0 Pink® Thermal Slab HD foil faced and R1.3 55mm Pink® Building Blanket on ceiling	R5.5	R6.3	69	72	EE
	R2.3 75mm Pink® Thermal Slab foil faced and R1.8 75mm Pink® Building Blanket on ceiling	R5.3	R6.2	69	72	

1. Special measures to reduce flanking would be required to achieve the potential performance of these constructions outside of the laboratory.

NOTES

- A: Calculations and assumptions in accordance with AS/NZS4859.1:2002 Including Amendment 1: 2006 on the path of insulation as required by BCA Volume 1. Part J and Volume 2. Section 3:12, 2011.
- B. Temperatures and Parameters are based on Australian climate assumptions. Air temperature difference 12°C (36°C less 24°C) for summer conditions and 6°C difference (18°C less 12°C) for winter. Actual conditions may differ from standardised conditions. This will impact on the actual performance of the insulation.
- C. Thermal resistance of air films and attic spaces based on values obtained from Section K5 and K6 of AS/NZS 4859.1: 2002 Including Amendment 1: 2006.
- D. Building material elements based on 2000 AIRAH Handbook and attic thermal value based on AS/NZS4859.1: 2002 Including Amendment 1: 2006 App K6 table K2.
- E. Where reflective insulation is installed, a simple addition of R-values is not possible. Care must be taken to ensure the performance of reflective air spaces is not 'double counted'.
- F. The emittance of the reflective surfaces are dependent on tested values and the conditions of the installation, as specified by AS/NZS4859.1: 2002 Including Amendment 1: 2006.
- G. All Residential roofing calculations in this handbook are based on a dark coloured roof. All Commercial roofing calculations in this handbook are based on a light coloured roof. Please refer to the colour absorbance chart for use of coloured roofs. Also refer to roofing material manufacturer's classification of type of colour for their range. Please contact 1800 000 878 for a customised solution.
- H. The Rw estimate tolerance is ± 3dB.

LEGEND:

- ME** Most Economical
RE Recommended
BV Best Value
TB Thermal Break
EE Most Energy Efficient
RW Best Sound Reduction
FA Fall Arrest

SECTION 5: COMMERCIAL ROOFING AND CEILING SYSTEMS

COMMERCIAL CONCRETE ROOF WITH SUSPENDED CEILING 600mm-1200mm (NON VENTILATED)

STRUCTURE

150mm concrete suspended floor slab with exterior waterproofing membrane. Reflective Insulation Material fixed below slab. 600mm to 1200mm airspace below slab with 10mm plasterboard fixed to suspended ceiling.

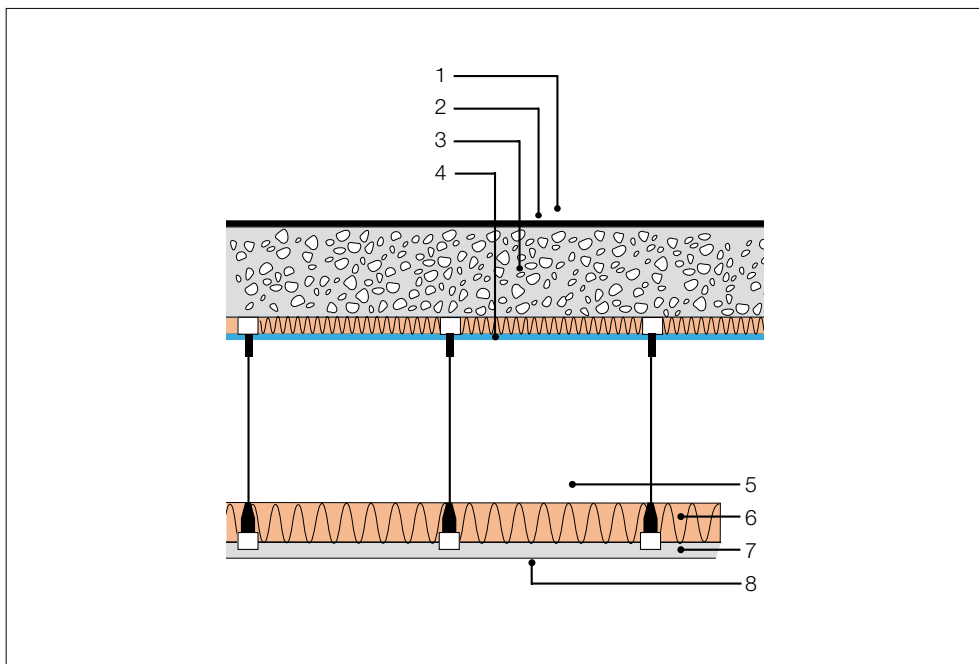

1. Indoor air-film
2. Roof waterproofing membrane
3. 150mm concrete slab
4. Pink® Thermal Slab HD (Reflective insulation Material)
5. Unventilated (600mm-1200mm) air space
6. Pink® Building Blanket
7. 10mm standard plasterboard
8. Indoor air-film (non reflective surface)

CAD illustrations: www.insulation.com.au/greenbook

CLIMATE ZONES 1 - 6 Direction of heat flow = downward (summer) Minimum BCA = R3.2	PRODUCT VARIATIONS	TOTAL SYSTEM R-VALUES		SOUND REDUCTION INDEX (Rw) ¹		SYSTEM FEATURE
	NON-VENTILATED	WINTER	SUMMER	600mm	1200mm	
	R1.5 50mm Pink® Thermal Slab	R2.4	R4.7	72	72	RE
	R1.3 55mm Permastop® with Heavy Duty Sisalation®	R2.2	R4.5	72	72	ME, EE
	R1.8 75mm Permastop® with Heavy Duty Sisalation®	R2.7	R5.0	72	72	BV
	R2.5 100mm Permastop® with Heavy Duty Sisalation®	R3.5	R5.7	72	72	
	R1.3 55mm Permastop® with 55mm (R1.3) Pink® Building Blanket on ceiling	R3.6	R5.8	72	72	EE

CLIMATE ZONE 7 Direction of heat flow = upward (winter) Minimum BCA = R3.7	PRODUCT VARIATIONS	TOTAL SYSTEM R-VALUES		SOUND REDUCTION INDEX (Rw)		SYSTEM FEATURE
	NON-VENTILATED	WINTER	SUMMER	600mm	1200mm	
	R3.0 100mm Pink® Thermal Slab HD Foil Faced	R3.9	R6.3	72	72	RE
	R3.0 130mm Permastop® with Heavy Duty Sisalation®	R3.5	R5.7	72	72	BV
	R1.8 75mm Permastop® with R1.3 55mm Pink® Building Blanket on ceiling	R4.1	R6.3	72	72	ME, EE

CLIMATE ZONE 8 Direction of heat flow = upward (winter) Minimum BCA = R4.8	PRODUCT VARIATIONS	TOTAL SYSTEM R-VALUES		SOUND REDUCTION INDEX (Rw)		SYSTEM FEATURE
	NON-VENTILATED	WINTER	SUMMER	600mm	1200mm	
	R1.5 50mm Pink® Thermal Slab with R2.5 100mm Permastop® HD Building Blanket on ceiling	R5.0	R7.3	72	72	RE
	R1.3 55mm Permastop® with R2.5 100mm Pink® Building Blanket on ceiling	R4.8	R7.0	72	72	BV
	R3.0 100mm Pink® Thermal Slab R1.3 55mm Pink® Building Blanket on ceiling	R5.0	R5.9	72	72	EE
	R2.3 75mm Pink® Thermal Slab and R1.8 75mm Pink® Building Blanket on ceiling	R5.1	R7.4	72	72	

1. Special measures to reduce flanking would be required to achieve the potential performance of these constructions outside of the laboratory.

NOTES

- A. Calculations and assumptions in accordance with AS/NZS4859.1:2002 Including Amendment 1: 2006 on the path of insulation as required by BCA Volume 1. Part J and Volume 2. Section 3:12, 2011.
- B. Temperatures and Parameters are based on Australian climate assumptions. Air temperature difference 12°C (36°C less 24°C) for summer conditions and 6°C difference (18°C less 12°C) for winter. Actual conditions may differ from standardised conditions. This will impact on the actual performance of the insulation.
- C. Thermal resistance of air films and attic spaces based on values obtained from Section K5 and K6 of AS/NZS 4859.1: 2002 Including Amendment 1: 2006.
- D. Building material elements based on 2000 AIRAH Handbook and attic thermal value based on AS/NZS4859.1: 2002 Including Amendment 1: 2006 App K6 table K2.
- E. Where reflective insulation is installed, a simple addition of R-values is not possible. Care must be taken to ensure the performance of reflective air spaces is not 'double counted'.
- F. The emittance of the reflective surfaces are dependent on tested values and the conditions of the installation, as specified by AS/NZS4859.1: 2002 Including Amendment 1: 2006.
- G. All Residential roofing calculations in this handbook are based on a dark coloured roof. All Commercial roofing calculations in this handbook are based on a light coloured roof. Please refer to the colour absorbance chart for use of coloured roofs. Also refer to roofing material manufacturer's classification of type of colour for their range. Please contact 1800 000 878 for a customised solution.
- H. The Rw estimate tolerance is ± 3dB.
- I. Thermal resistance contribution of the unventilated ceiling plenum is determined for a thickness of 600mm (a conservative estimate for thickness up to 1200mm) in accordance with ISO6946: 2007 where the width and length dimensions of the airspace are greater than 10 times its thickness, and the area of any openings does not exceed 500mm² per square metre of surface area.

LEGEND:

ME	Most Economical
RE	Recommended
BV	Best Value
TB*	Thermal Break
EE	Most Energy Efficient
RW	Best Sound Reduction
FA	Fall Arrest

This page is left blank intentionally

Section 6: Commercial wall systems

Commercial metal clad wall (warehouse purlin girt wall with no internal lining)
Pg 82

Commercial metal clad wall with internal lining (warehouse wall with internal lining 100mm – 150mm cavity).
Pg 83

Commercial concrete tilt slab (with internal lining). Pg 84

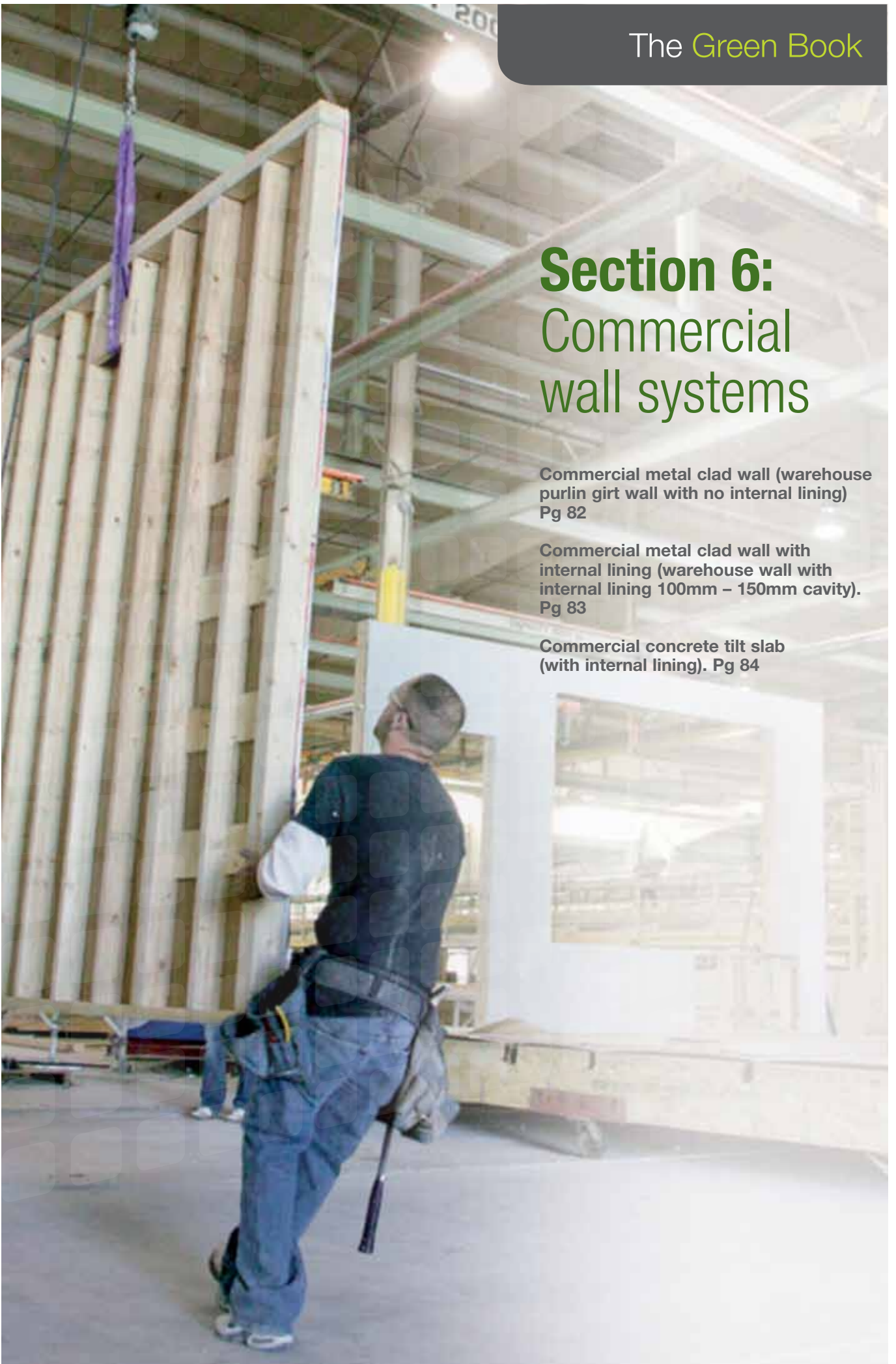

SECTION 6: COMMERCIAL WALL SYSTEMS

COMMERCIAL METAL CLAD WALL (WAREHOUSE PURLIN GIRT WALL WITH NO INTERNAL LINING)

STRUCTURE

External metal cladding. Insulation spacer, wire mesh and girt. Bulk reflective insulation material, bright side facing inwards.

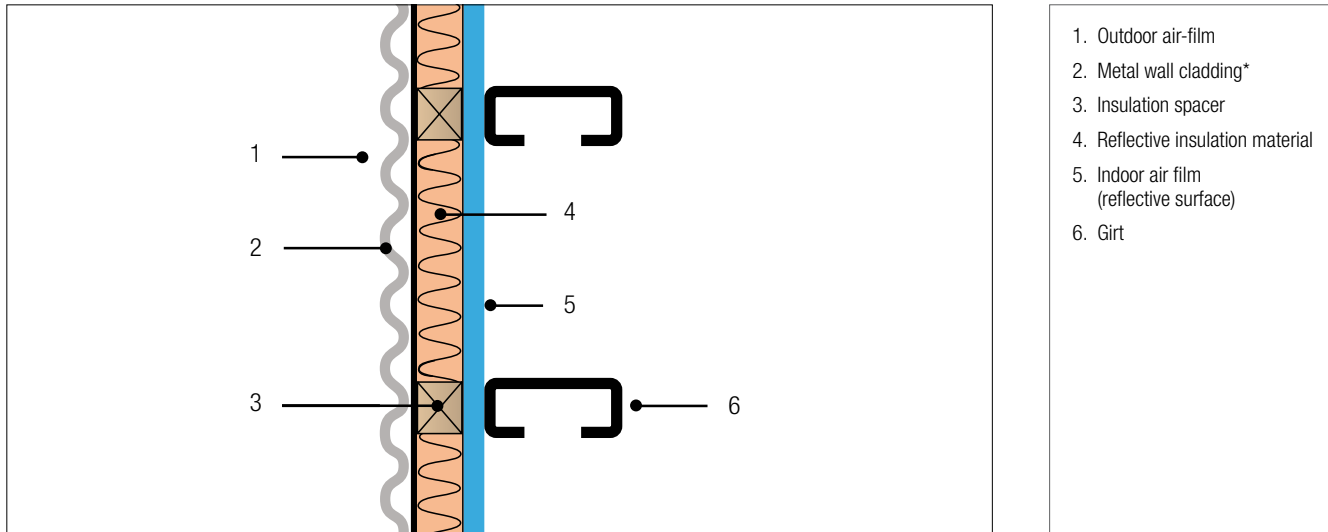

1. Outdoor air-film
2. Metal wall cladding*
3. Insulation spacer
4. Reflective insulation material
5. Indoor air film (reflective surface)
6. Girt

CAD illustrations: www.insulation.com.au/greenbook

CLIMATE ZONES 1 -3 Direction of heat flow = Inward (Summer) Minimum BCA R3.3	PRODUCT VARIATIONS		TOTAL SYSTEM R-VALUES		SOUND REDUCTION INDEX (Rw)	SYSTEM FEATURE
	NON-VENTILATED		WINTER	SUMMER		
CLIMATE ZONES 4 -7 Direction of heat flow = Inward (Summer) (Climate Zones 4-6) Minimum BCA = R2.8 Direction of heat flow = Outward (Winter) (Climate Zone7) Minimum BCA = R2.8	Call 1800 000 878 for a solution				20	
CLIMATE ZONE 8 Direction of heat flow = Outward (Winter) Minimum BCA = R3.8						

^ Required where steel trusses are used
* Rw calculation based on Corrugated 0.48mm BMT metal roof.

NOTES

- A: Calculations and assumptions in accordance with AS/NZS4859.1:2002 Including Amendment 1: 2006 on the path of insulation as required by BCA Volume 1. Part J and Volume 2. Section 3:12, 2011.
- B: Temperatures and Parameters are based on Australian climate assumptions. Air temperature difference 12°C (36°C less 24°C) for summer conditions and 6°C difference (18°C less 12°C) for winter. Actual conditions may differ from standardised conditions. This will impact on the actual performance of the insulation.
- C: Thermal resistance of air films and attic spaces based on values obtained from Section K5 and K6 of AS/NZS 4859.1: 2002 Including Amendment 1: 2006.
- D: Building material elements based on 2000 AIRAH Handbook and attic thermal value based on AS/NZS4859.1: 2002 Including Amendment 1: 2006 App K6 table K2.
- E: Where reflective insulation is installed, a simple addition of R-values is not possible. Care must be taken to ensure the performance of reflective air spaces is not 'double counted'.
- F: The emittance of the reflective surfaces are dependent on tested values and the conditions of the installation, as specified by AS/NZS4859.1: 2002 Including Amendment 1: 2006.
- G: All Residential roofing calculations in this handbook are based on a dark coloured roof. All Commercial roofing calculations in this handbook are based on a light coloured roof. Please refer to the colour absorbance chart for use of coloured roofs. Also refer to roofing material manufacturer's classification of type of colour for their range. Please contact 1800 000 878 for a customised solution.
- H: The Rw estimate tolerance is ± 3dB.

- LEGEND:
- ME** Most Economical
 - RE** Recommended
 - BV** Best Value
 - TB** Thermal Break
 - EE** Most Energy Efficient
 - RW** Best Sound Reduction
 - FA** Fall Arrest

SECTION 6: COMMERCIAL WALL SYSTEMS

COMMERCIAL METAL CLAD WALL WITH INTERNAL LINING (WAREHOUSE WALL WITH INTERNAL LINING 100MM – 150MM CAVITY)

STRUCTURE

External metal cladding. 40mm spacer, wire mesh and girt. Spacer installed over Permastop® Building Blanket to ensure blanket recovers to full nominal thickness. Sisalation® facing interior space, with wire mesh. 100mm – 150mm girt framing forming a non-vented air space, batten to support internal lining (compressed fibre cement or plasterboard).

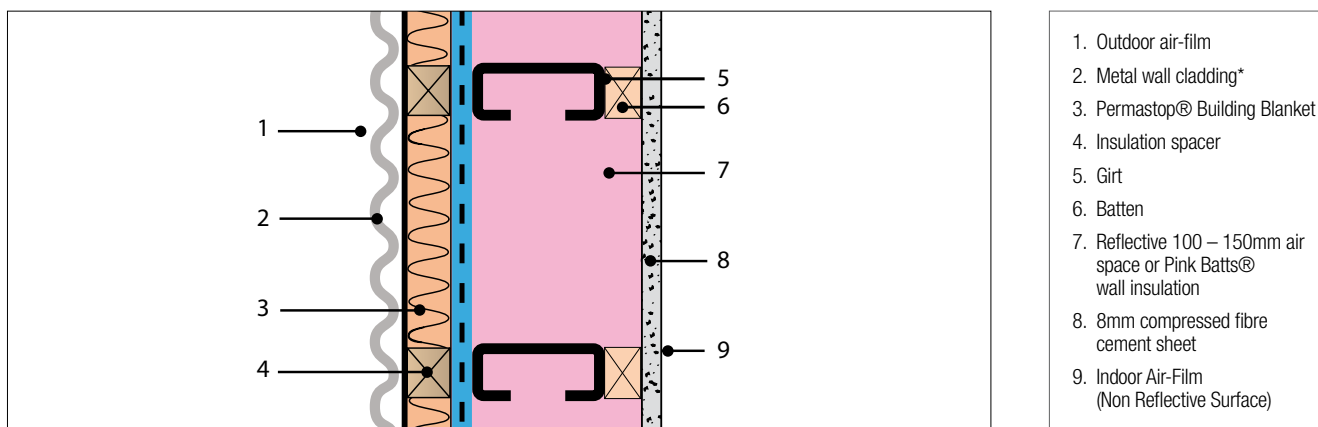

CAD illustrations: www.insulation.com.au/greenbook

CLIMATE ZONES 1 -3 Direction of heat flow = Inward (summer) Minimum BCA R3.3	PRODUCT VARIATIONS	TOTAL SYSTEM R-VALUES		SOUND REDUCTION INDEX (R _w)	SYSTEM /FEATURE
	NON-VENTILATED	WINTER	SUMMER		
	R1.3 55mm Permastop® with R1.5 Pink Batts®	R3.9	R3.5	46	

^ Required where steel trusses are used

* R_w calculation based on Corrugated 0.48mm BMT metal roof.

CLIMATE ZONES 4 -7 Direction of heat flow = Inward (Summer) (Climate Zones 4-6) Direction of heat flow = Outward (Winter) (Climate Zone7) Minimum BCA = R2.8	PRODUCT VARIATIONS	TOTAL SYSTEM R-VALUES		SOUND REDUCTION INDEX (R _w)	SYSTEM /FEATURE
	NON-VENTILATED	WINTER	SUMMER		
	R1.3 55mm Permastop® with R1.5 Pink Batts®	R3.9	R3.5	46	

CLIMATE ZONE 8 Direction of heat flow = Outward (Winter) Minimum BCA = R3.8	PRODUCT VARIATIONS	TOTAL SYSTEM R-VALUES		SOUND REDUCTION INDEX (R _w)	SYSTEM /FEATURE
	NON-VENTILATED	WINTER	SUMMER		
	R1.8 75mm Permastop® with R2.5 Pink Batts®	R5.5	R4.9	46	

NOTES

A: Calculations and assumptions in accordance with AS/NZS4859.1:2002 Including Amendment 1: 2006 on the path of insulation as required by BCA Volume 1. Part J and Volume 2. Section 3:12, 2011.

B. Temperatures and Parameters are based on Australian climate assumptions. Air temperature difference 12°C (36°C less 24°C) for summer conditions and 6°C difference (18°C less 12°C) for winter. Actual conditions may differ from standardised conditions. This will impact on the actual performance of the insulation.

C. Thermal resistance of air films and attic spaces based on values obtained from Section K5 and K6 of AS/NZS 4859.1: 2002 Including Amendment 1: 2006.

D. Building material elements based on 2000 AIRAH Handbook and attic thermal value based on AS/NZS4859.1: 2002 Including Amendment 1: 2006 App K6 table K2.

E. Where reflective insulation is installed, a simple addition of R-values is not possible. Care must be taken to ensure the performance of reflective air spaces is not 'double counted'.

F. The emittance of the reflective surfaces are dependent on tested values and the conditions of the installation, as specified by AS/NZS4859.1: 2002 Including Amendment 1: 2006.

G. All Residential roofing calculations in this handbook are based on a dark coloured roof. All Commercial roofing calculations in this handbook are based on a light coloured roof. Please refer to the colour absorbance chart for use of coloured roofs. Also refer to roofing material manufacturer's classification of type of colour for their range. Please contact 1800 000 878 for a customised solution.

H. The R_w estimate tolerance is ± 3dB.

LEGEND:

	Most Economical
	Recommended
	Best Value
	Thermal Break
	Most Energy Efficient
	Best Sound Reduction
	Fall Arrest

SECTION 6: COMMERCIAL WALL SYSTEMS

COMMERCIAL CONCRETE TILT SLAB (WITH INTERNAL LINING)

STRUCTURE

150mm tilt slab concrete, commercial wall batts. 10mm plasterboard interior lining.

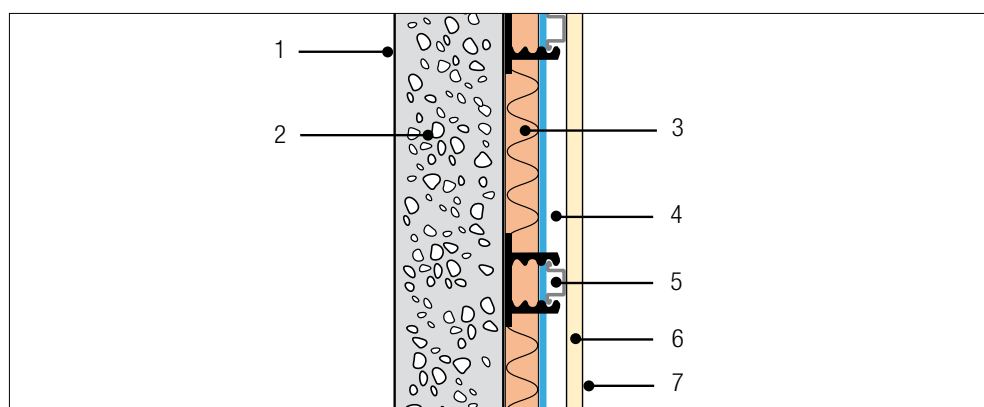

1. Outdoor air-film
2. 150mm concrete tilt slab
3. Pink® Partitton 22
4. Unventilated air space
5. Steel studs
6. 10mm standard plasterboard
7. Indoor air-film (non-reflective surface)

CAD illustrations: www.insulation.com.au/greenbook

CLIMATE ZONES 1 - 6 Direction of heat flow = Inward (Summer) Minimum BCA = R3.3	PRODUCT VARIATIONS	TOTAL SYSTEM R-VALUES		SOUND REDUCTION INDEX (Rw) ¹	SYSTEM FEATURE
	NON-VENTILATED	WINTER	SUMMER		
	R2.8 90mm Pink® Partitton 22 in 92mm steel stud offset 10mm from tilt slab	R3.0	R2.7	73	ME RE
	2 layers of R1.8 64mm Pink® Partitton 22 in 92mm steel stud offset 50mm from tilt slab	R4.1	R3.7	73	
	R3.5 130mm Pink® Partitton 22 in 92mm steel stud offset 50mm from tilt slab	R4.0	R3.6	74	EE

1. Special measures to reduce flanking would be required to achieve the potential performance of these constructions outside of the laboratory.

CLIMATE ZONES 7 Direction of heat flow = Outward (Winter) Minimum BCA = R2.8	PRODUCT VARIATIONS	TOTAL SYSTEM R-VALUES		SOUND REDUCTION INDEX (Rw)	SYSTEM FEATURE
	NON-VENTILATED	WINTER	SUMMER		
	R2.8 90mm Pink® Partitton 22 in 92mm steel stud offset 10mm from tilt slab	R3.0	R2.7	73	ME RE EE

CLIMATE ZONES 8 Direction of heat flow = upward (Winter) Minimum BCA = R4.8	PRODUCT VARIATIONS	TOTAL SYSTEM R-VALUES		SOUND REDUCTION INDEX (Rw)	SYSTEM FEATURE
	NON-VENTILATED	WINTER	SUMMER		
	Call 1800 000 878 for a solution				

NOTES

- A: Calculations and assumptions in accordance with AS/NZS4859.1:2002 Including Amendment 1: 2006 on the path of insulation as required by BCA Volume 1. Part J and Volume 2. Section 3:12, 2011.
- B: Temperatures and Parameters are based on Australian climate assumptions. Air temperature difference 12°C (36°C less 24°C) for summer conditions and 6°C difference (18°C less 12°C) for winter. Actual conditions may differ from standardised conditions. This will impact on the actual performance of the insulation.
- C: Thermal resistance of air films and attic spaces based on values obtained from Section K5 and K6 of AS/NZS 4859.1: 2002 Including Amendment 1: 2006.
- D: Building material elements based on 2000 AIRAH Handbook and attic thermal value based on AS/NZS4859.1: 2002 Including Amendment 1: 2006 App K6 table K2.
- E: Where reflective insulation is installed, a simple addition of R-values is not possible. Care must be taken to ensure the performance of reflective air spaces is not 'double counted'.
- F: The emittance of the reflective surfaces are dependent on tested values and the conditions of the installation, as specified by AS/NZS4859.1: 2002 Including Amendment 1: 2006.
- G: All Residential roofing calculations in this handbook are based on a dark coloured roof. All Commercial roofing calculations in this handbook are based on a light coloured roof. Please refer to the colour absorbance chart for use of coloured roofs. Also refer to roofing material manufacturer's classification of type of colour for their range. Please contact 1800 000 878 for a customised solution.
- H: The Rw estimate tolerance is ± 3dB.

LEGEND:

- ME Most Economical
- RE Recommended
- BV Best Value
- TB Thermal Break
- EE Most Energy Efficient
- RW Best Sound Reduction
- FA Fall Arrest

Fletcher Insulation™ Branch Network

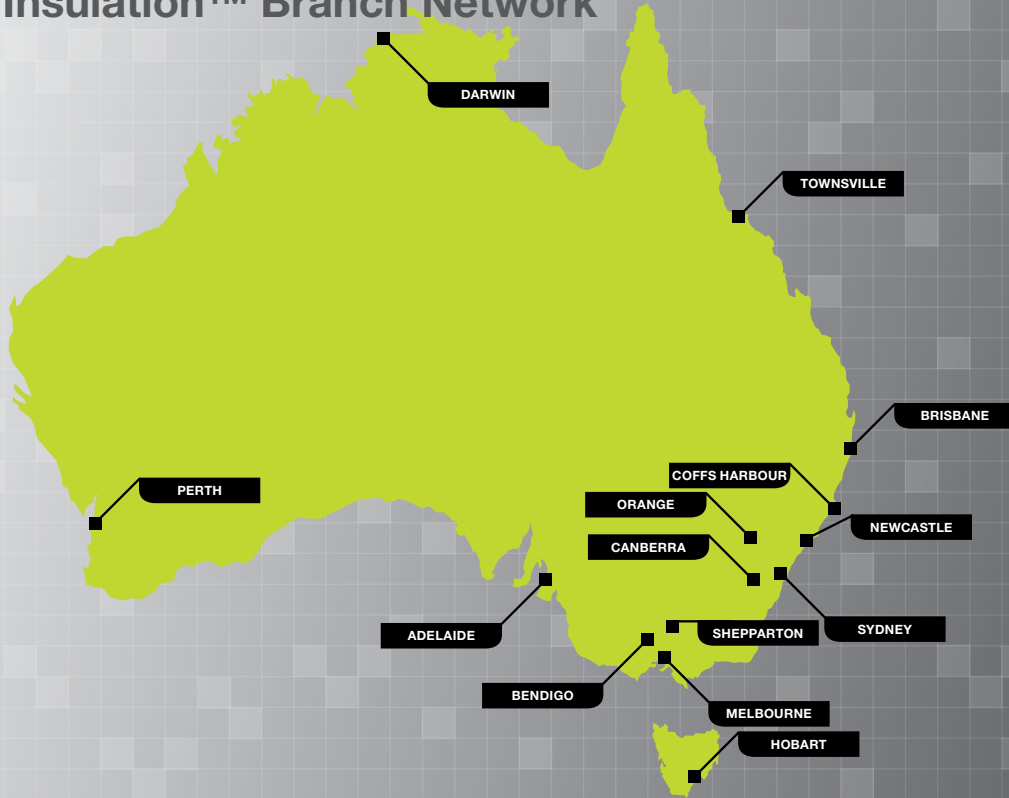

Branches

NEW SOUTH WALES

Sydney (Head Office)
161 Arthur St
Homebush NSW 2140
Phone 02 9752 9200
Fax 02 9764 3175

Sydney (Sales Office)
600 Woodstock Ave
Rooty Hill NSW 2766
Phone 02 9677 4444
Fax 02 9832 3043

Coffs Harbour
36B High Tech Rd
Toorina NSW 2452
Phone 02 6658 9561
Fax 02 6658 9546

Newcastle
18 Arunga Drive
Beresfield NSW 2322
Phone 02 4944 6100
Fax 02 4966 8156

Orange
16 Edward St
Orange NSW 2800
Phone 02 6361 9789
Fax 02 6361 9707

ACT
Canberra
Unit 2, 28 Sheppard St
Hume ACT 2620
Phone 02 6260 2695
Fax 02 6260 2712

QUEENSLAND
Brisbane
91 Stradbroke St
Heathwood QLD 4110
Phone 07 3120 1100
Fax 07 3879 6076

Townsville
760-764 Ingham Rd
Bohle QLD 4818
Phone 07 4774 3579
Fax 07 4774 3582

TASMANIA
Hobart
95 Albert Rd
Moonah TAS 7009
Phone 03 6228 0944
Fax 03 6228 0961

SOUTH AUSTRALIA
Adelaide
519-523 Grand Junction Rd
Wingfield SA 5013
Phone 08 8340 6400
Fax 08 8243 0024

VICTORIA
Melbourne
127 Dandenong/Frankston Rd,
Dandenong VIC 3175
Phone 03 9797 1234
Fax 03 9797 1279

Bendigo
81-83 Beischer St
Bendigo VIC 3550
Phone 03 5444 5088
Fax 03 5444 4207

Shepparton
62 Florence St
Shepparton VIC 3630
Phone 03 5821 7097
Fax 03 5822 4752

NORTHERN TERRITORY
Darwin
Unit 1, 2 and 3/Lot 4920
College Road,
Berrimah NT 0828
Phone 08 8947 3662
Fax 08 8947 3665

WESTERN AUSTRALIA
Perth
13-17 Hurley St
Canning Vale WA 6155
Phone 08 9456 0199
Fax 08 9456 0109

NEED HELP?

For further information on Total R-value calculations for typical roof and wall systems performance please contact Fletcher Insulation's Specifier Advisory Service Team on:

TECHNICAL-1800 000 878 SALES-1300 654 444
info@insulation.com.au www.insulation.com.au

Additional assistance on Total R-values can also be found in the ICANZ Insulation Handbook at www.icanz.org.au

Fletcher[®]
Insulation

Fletcher Insulation
161 Arthur St, Homebush
NSW Australia 2140

P (02) 9752 9200
F (02) 9764 3175
E info@insulation.com.au



Nordland Papier, Germany
HSE registration number D-162-00007.

This material is printed on Novatech Satin from UPM Kymmene's EMAS accredited mills and is Carbon Neutral. The pulp for this paper is sourced from certified, well managed plantation forests. EMAS is the European Union's regulated environmental management scheme.

Novatech is an EMAS certified stock produced by UPM Kymmene, Nordland - Germany.
Mill registration No.D - 162 - 00007 and ISO 14001.