

MORE FROM WOOD.



PROFESSIONAL



OS'BRACE®

› The environmentally sustainable
bracing panel

www.egger.com/osbrace

THE ENVIRONMENTALLY SUSTAINABLE BRACING PANEL

WHAT IS OS'Brace®?

OS'Brace® is a high quality, moisture resistant, innovative and environmentally sustainable, structural bracing panel designed and manufactured specifically for the Australian building and construction industry.

WHAT IS OS'Brace® H2 Blue?

OS'Brace® H2 Blue is a termite-treated OS'Brace® panel to H2 level complementing your fully termite-treated timber framing package. The H2 Blue treatment is effective against termite species throughout Australia (North and South of the Tropic of Capricorn).

MADE IN EUROPE

OS'Brace® is a three-layered, flat-pressed EGGER EUROSTRAND® OSB panel of oriented strands (micro-veneers) bonded with synthetic resin in accordance with EN 300:2006 OSB. The panel is principally made of debarked round wood from sustainable managed forests. Separate strand processing for the core and surface layers, special strand geometry and a high level of orientation of the surface strands in the direction of the fibre optimises OS'Brace®'s structural performance and physical appearance.



Architects, carpenters and home owners appreciate the beauty, flexibility and advantages of using wood as a building material. Designed to perform OS'Brace® made by EGGER fulfills these expectations.

BENEFITS OF EGGER OS'BRACE® AT A GLANCE



- OS'Brace® panels are made in EGGER's world's most modern OSB plants from **environmentally sustainable wood resources** – conserving the world's threatened tropical forests. OS'Brace® is manufactured in **European plants** which are certified according to the chain-of-custody schemes of FSC and PEFC. Wood purchase is annually audited according to FSC "Controlled Wood" (CW) standard.



- OS'Brace® provides a consistent, high quality bracing panel supported by fast and reliable delivery and service.
- OS'Brace®'s third party plant certification ensures that OS'Brace® has consistent adherence to international OSB quality standards manufactured under quality management system ISO 9001:2008. Several external plant supervision systems, such as CE-marking (European Community), JAS (Japanese Agricultural Standard) or PS2-04 (US Building Code), guarantee superior product quality.

Complies with BCA

- OS'Brace®'s **high moisture tolerance** provides a structural bracing panel with **long term performance** and **excellent dimensional stability** once OS'Brace® is conditioned to the in-service equilibrium moisture content (EMC).

- OS'Brace® is a **low formaldehyde** emitting product which fulfils the most stringent European E1 (< 0.1 ppm) regulations.

- OS'Brace® is a strong and durable, engineered wood panel with consistent structural properties. It resists splitting and delamination. It has a clean fresh wood appearance with none of the typical veneer defects of plywood such as holes, knots and splits.

- The OS'Brace® system has been engineered and tested to **comply with the performance requirements of the National Construction Code (NCC)** incorporating the Building Code of Australia (BCA). The design criteria are based upon AS 1684–1999 residential timber framed construction.



- OS'Brace® provides four simple bracing systems, offering up to 6 kN/m racking resistance. OS'Brace®'s bracing capacities are based on fixing to minimum JD5 framing. OS'Brace® also provides a short wall bracing solution where wall space is limited.

- OS'Brace® satisfies the performance requirements of the NCC incorporating BCA demonstrated by structural equivalency. The product and system, specific to the requirements specified in the OS'Brace® brochure, has been certified by Professor Keith Crews (UTS). This is a generic certification and should not be seen to be site specific.

- OS'Brace® is simple to install, being lightweight, easy to cut, nail, screw and drill.



- OS'Brace® H2 Blue is a termite-treated OS'Brace® panel to H2 level complementing **fully termite-treated timber** framing packages now available in Australia and is registered throughout Australia. OS'Brace® H2 Blue panels have a **full cross-sectional glue-line treatment against termite attack**, complying with the requirements of minimum preservative retention to enable the use of OS'Brace® in all regions of Australia (North and South of the Tropic of Capricorn).

- H2 panels can be easily identified by the blue stamping, blue H2 pallet sticker and blue panel edge colour stripes.



OS'BRACE® SYSTEM DESIGN AND INSTALLATION

INSTALLATION

OS'Brace® should be installed in accordance with standard building design and construction methods. Prolonged exposure to moisture and excessive condensation must not occur.

OS'Brace® is suitable for use in humid conditions where the panel in-service moisture content does not exceed 20%. This is defined in EN 13986:2004 as service class 2. This service class is appropriate for the installation of OS'Brace® within the cavity of a brick veneer building or under cladding throughout Australia.

As is the case with all wood-based products, OS'Brace® is hygroscopic, meaning that the panel's final resting moisture content will adjust to the equilibrium moisture content (EMC) of the site. Correct installation procedure must be observed to allow for the small dimensional movement in the OS'Brace® panel in response to changes in EMC.

OS'Brace® should be allowed to acclimatise (pick up moisture) for at least a 48 hour period prior to installation.

FASTENER RECOMMENDATION

For the OS'Brace® systems detailed in the manual, 2.8 mm diameter x 30 mm flathead galvanised or corrosion resistant nails, or their gun-driven equivalent are specified according to AS 1684-1999. Fastener edge distances along top and bottom plates and edge studs should be a minimum of 15 mm and

DO NOT butt joint OS'Brace® panels tightly. To allow for hygroscopic movement, a minimum 2 mm expansion gap must be allowed around the full perimeter of the panel and at any butt joint between OS'Brace® panels.

HOLES THROUGH OS'BRACE® BRACING

As OS'Brace® possesses similar shear carrying capacity to other sheet bracing materials, allowable holes through OS'Brace® in size and distribution would be similar to these materials.

A hole 100 x 100 mm maximum within an envelope of 100 mm from top and vertical edges and 200 mm of the bottom of the bracing panel will not significantly affect the bracing capacity. Multiple holes of this size are permitted provided the centre lines of the holes are not closer than 600 mm.

8 mm where panels are fixed to internal framing. The table specifies the suitable fastening for OS'Brace® complying with EWPA recommendations. The fastener spacing for staples has to be reduced to two thirds of the spacing of nails or screws by multiplying the nail or screw spacing with the factor 0.66.

MINIMUM FASTENER SPECIFICATION

Hand Driven Nails	Power Driven Nails	Power Driven Staples
2.8 mm dia. x 30 mm flathead structural clouts or connector nails	Senco TN22-38 APB, 2.33 mm dia. x 38 mm flathead	Senco N167 BAB, wire dia. 1.53 mm, crown width 10.5 mm
–	Bostitch AC45P-250-GW, 2.5 mm dia. x 38 mm flathead	Bostitch BCS4-1232 wire dia. 1.55, crown width 12 mm
–	Jambro B20998, 2.8 mm dia. x 32 mm, zinc plate barb	Jambro A10617 G5562-38 mm wire dia. 1.53 mm, crown width 10.5 mm
–	Duo-Fast C27.32GDTN22-38 APB, 2.7 mm dia. x 32 mm dia. galvanised	–

→ Fasteners with equivalent dimensions, i.e. head size and shape, shank diameter and length to those in the table are deemed acceptable.

→ All fasteners are to be galvanised or suitably coated.

→ If smaller diameter hand driven nails are used, the spacing of nails can be reduced in the ratio of the basic lateral loads per nail for JD4 joint group given in table 4.1 of AS1720.1 Timber Structures – Design Methods for the lower nail diameter relative to the tabulated load for a 2.8 mm diameter nail.

SAWING, DRILLING, SHAPING

OS'Brace® can be sawn and shaped in the same way as solid wood with standard stationary tools and (electrical) hand-held tools. Carbide tipped cutters are recommended. If panels are to be installed in a visible location, ensure clean-cut edges with sharp tools.

The feed rate should be somewhat slower than for solid wood. If hand-held equipment without suction removal is used, a protective face mask should be worn. OS'Brace® may be drilled with all electrical and hand-held tools suitable for solid wood.



OS'BRACE® BRACING CAPACITY

The racking resistance values for OS'Brace® have been derived from independent testing of full scale prototype panels at the Faculty of Engineering and Physical Systems, Central Queensland University. The testing methods used have been developed over three decades by the CQU and have been calibrated to over 30 years of actual performance in buildings around Australia subjected to real wind forces. Therefore the OS'Brace® racking values published in the manual can be used with great confidence and have been independently certified by the University of Technology Sydney as complying with the requirements of the Building Code of Australia. Bracing capacities for OS'Brace® systems are given in the diagrams on the next pages for various fixing methods applicable for wall heights of up to 2.7 m. For wall heights exceeding 2.7 m, bracing resistances detailed must be reduced proportionally, e.g. for a wall height of 3.3 m, racking resistance reduction factor $2.7/3.3 = 0.82$. Minimum section (length of bracing) for system types 1, 2 and 3 is 900 mm.

ANCHORING BOTTOM PLATES

Anchoring of bottom plates shall be in accordance with AS 1684-1999 or designed in accordance with AS 1720.1-1997. Hold down provided in the OS'Brace® bracing system provides bracing resistance. Additional fixings (cyclone rods) may be required to resist uplift forces and must be appropriately designed and installed.

UPLIFT RESISTANCE OF OS'BRACE® SHEATHED WALLS

The uplift resistance of OS'Brace® sheathed walls was established by testing the failure in tension of full scale prototype sections of the OS'Brace® sheathed, timber-framed wall panels. The testing was conducted independently at the University of Technology Sydney (UTS) and the design values were engineer-certified by Professor Keith Crews.

The table shows allowable uplift resistances of OS'Brace® sheathed wall systems with minimum rafter or truss spacing of 900 mm.

Allowable uplift resistance [kN/rafter]	Fastener spacing (mm) top and bottom plates
7.5	80
8.5	40

Wind uplift loads are transferred to the wall panels via the rafter or truss to top plate connection. The OS'Brace® sheathed wall frames transfer these uplift loads to the bottom plates, the OS'Brace® acting in tension as a continuous cycle rod as depicted in the figure above.

BRICK TIES

When used in the cavity of a brick veneer, brick wall ties must be of the face-fixed type complying with AS 2699. The ties should be nailed through the OS'Brace® to the face of the stud.

DESIGN SCOPE

Where the building design or design wind speed parameters are outside the scope of AS 1684-1999, a professional engineer should be consulted to determine the wind forces generated from AS 4055-1992 or directly from AS 1170.2-1989.

TIMBER FRAMING

OS'Brace® racking resistances detailed in the manual were generated using framing timbers with nail holding resistance of JD5 and a maximum stud spacing of 600 mm centres. Therefore, no reduction factors are applicable for fixing to JD5, unlike plywood which requires a 12.5% reduction factor, and hardboard, a 16% reduction factor, when material reduces in joint strength group from JD4 to JD5. Where timber framing is of joint strength group JD4, independent testing has confirmed that the racking resistances given in this literature for OS'Brace® system types 1, 2, 3 and 4 can be increased by a maximum of 10%.

Top plate to rafter or truss connection as per AS 1684

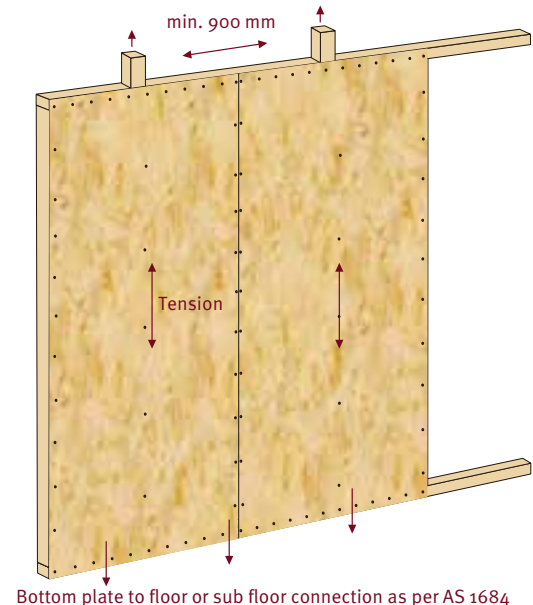

OS'BRACE® SYSTEMS

The allowable racking resistances for the OS'Brace® systems Type #1 to Type #4 in this literature are applicable to frames sheathed on one side only. The resistances may be doubled for frames sheathed on two (both) sides provided that the hold

down requirements of the bottom plate is also doubled. Under these circumstances, bottom plate sizes must be checked to ensure safe moment capacity.

TYPE #1 | SYSTEM 3.4 KN/M

- Fastener centres
 - 80 mm for top and bottom plates
 - 150 mm for vertical edges
 - 300 mm for intermediate studs
- Minimum section of bracing of 900 mm
- 2 mm expansion gap around perimeter of every panel
- For panel length of 600 mm bracing capacity shall be half of that for 900 mm
- For panel length between 600 mm and 900 mm, the bracing capacity can be calculated by multiplying the respective capacities by 0.5 for 600 mm long varying linearly to 1.0 for 900 mm.

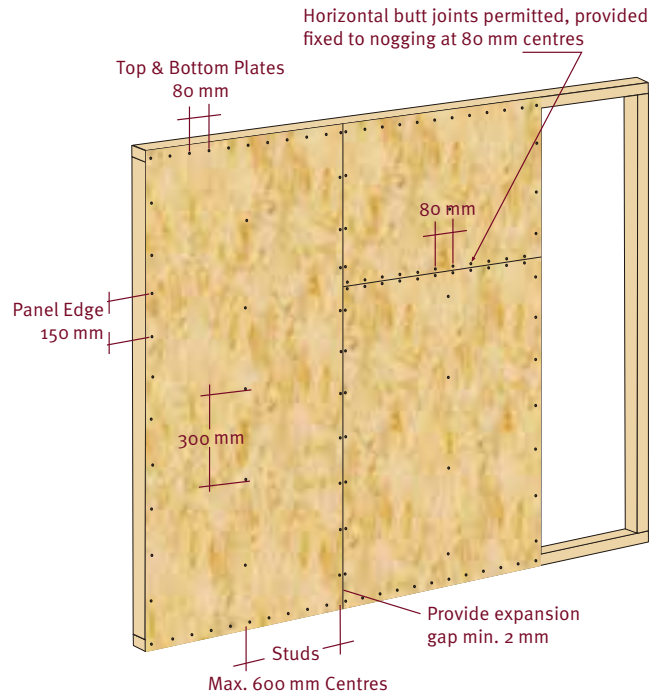

TYPE #2 | SYSTEM 5.6 KN/M

- Fastener centres
 - 80 mm for top and bottom plates
 - 150 mm for vertical edges
 - 300 mm for intermediate studs
 - M12 rod at ends of sheathed section
- Minimum section of bracing of 900 mm
- 2 mm expansion gap around perimeter of every panel

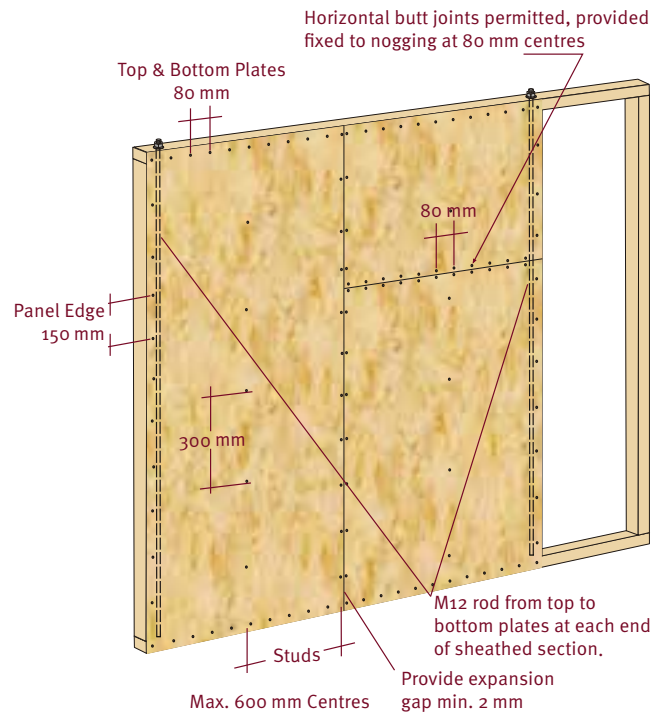

Note: For all above systems, minimum joint strength of framing JD5. No noggings required for full height sheets unless being used for internal wall bracing, see page 10.

Min. 2 mm expansion gap around perimeter of panel.

TYPE #3 | SYSTEM 6.0 KN/M

- Fastener centres
 - 40 mm for top and bottom plates
 - 150 mm for vertical edges
 - 300 mm for intermediate studs
- Minimum section of bracing of 900 mm
- 2 mm expansion gap around perimeter of every panel

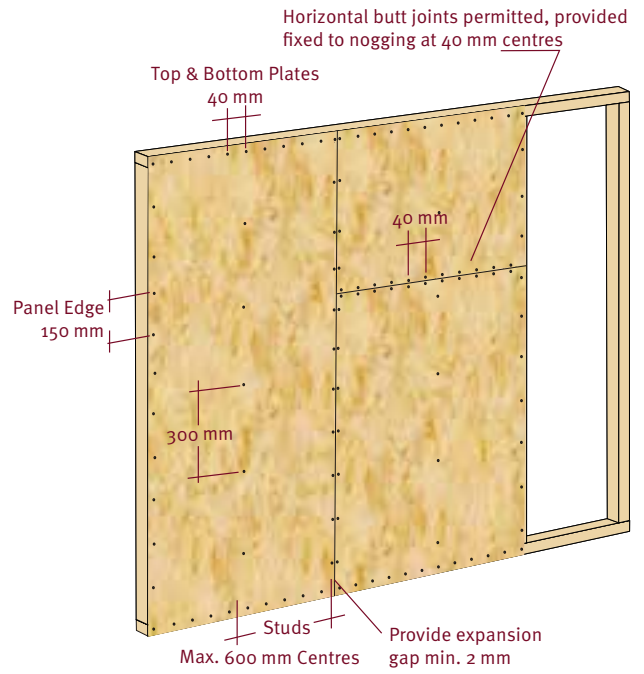

TYPE #4 | SHORT WALL BRACING | SYSTEM 2.2 KN/M

- 80 mm for top and bottom plates
- 150 mm for vertical edges
- M10 × 70 mm coach screws with 50 × 50 × 3 mm washers in each corner of each sheathed, short wall section
- Minimum section of bracing of 450 mm
- 2 mm expansion gap around perimeter of every panel

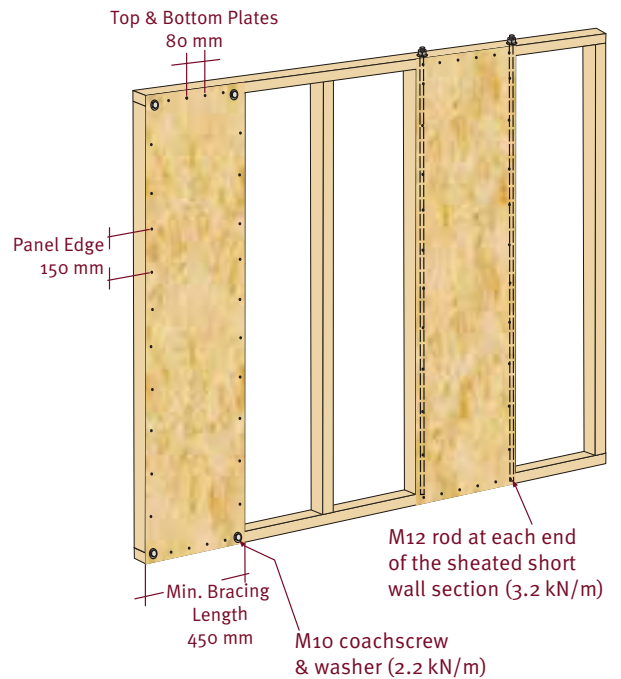

Note: Where the coach screws in the corners of the panels are replaced by a M12 rod at each end of the sheathed, short wall section, the bracing resistance of the Type #4 wall bracing system can be increased to 3.2 kN/m.

Note: For all above systems minimum joint strength of framing JD5. No noggings required for full height sheets.

Min. 2 mm expansion gap around perimeter of panel.

INTERNAL BRACING

Given that installation allowances are critical when OS'Brace® is fixed in internal wall applications which will subsequently be covered by plasterboard (dry wall), the following additional allowances must be made:

- Panels have to be conditioned to moisture content in use.
- A min. of a 2 mm expansion gap around the perimeter has to be provided

For guidance purposes, it has to be assumed that a change in panel moisture content will cause a dimensional change in panel width as given in the following table.

Increase of MC [%]	Dimensional change [mm]	
	Panel width 900 mm	Panel width 1200 mm
+ 3	0.81	1.08
+ 5	1.35	1.80
+ 6	1.62	2.16

Note: 6 mm OS'Brace® is designed and manufactured specifically as a bracing panel. It is not designed as lining panel. However, with suitable battening and design fixing, it may also perform well in this application.

In general terms, a 12 mm (or thicker) panel is recommended as a lining panel similar to plywood products. The extra thickness of 12 mm maintains a flatter surface.

STORAGE AND HANDLING

Correct storage and protective measures for shipping are essential to ensure problem-free installation. The following simple rules should be observed at all times.

- Store OS'Brace® panels horizontally on squared bearers. The max. span length should be 800 mm. The bearers should be equal in height.
- Steel bands should be removed immediately upon arrival at the installer's storage area.
- Should several packages be stacked on top of one another, bearers should be inserted in true alignment.
- OS'Brace® should be stored protected from direct exposure to the weather in a well-ventilated area. The panels must not be stored directly on the ground when on site.
- If the panels are to be moved by fork-lift truck, the bearers should be high enough to prevent damage.
- A 48-hour acclimatisation to humidity conditions at the site of installation must be provided, particularly if the panels are used as internal bracing combined with plasterboard lining.

EQUILIBRIUM MOISTURE CONTENT (EMC) AND CONDITIONS OF USE

Relative humidity of air	Approx. EMC [%]	Conditions of use
Dry conditions 30 % to 65 %	4 % to 11 %	Dry installations, no risk of wetting in service
Dry conditions 6 % to 5 %	11 % to 17 %	Risk of wetting during installation and risk of occasional wetting in service

RECOMMENDATION FOR INTERNAL BRACING WITH PLASTERBOARDS LINING:

max. centre-to-centre span
 $e \leq 450$ mm between studs,
 OS'Brace®, $t = 6$ mm,
 conditioned to EMC

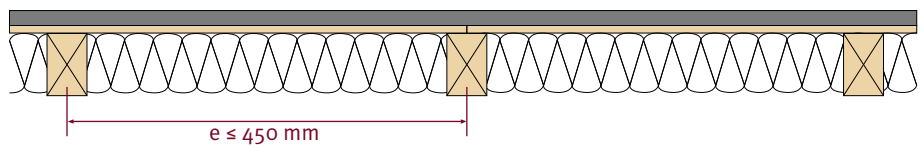

max. centre-to-centre span
 $e = > 450 - 600$ mm between studs,
 OS'Brace®, $t = 6$ mm,
 with additional horizontal noggings
 evenly distributed over the height:
 $h = 2440$ mm \rightarrow 2 noggings
 $h = 2745$ mm \rightarrow 2 noggings
 $h = 3050$ mm \rightarrow 3 noggings

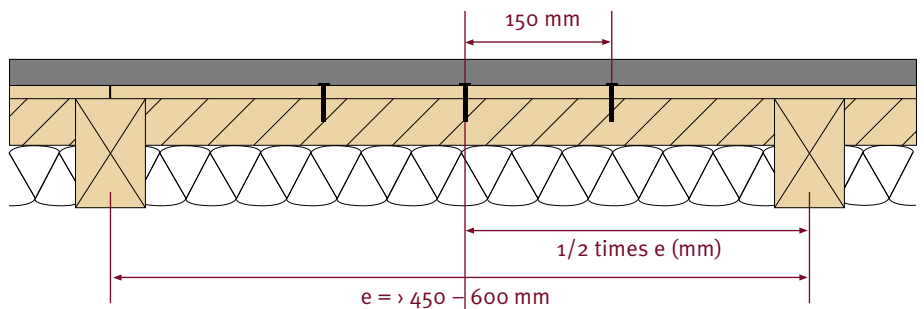

Note: OS'Brace® fixed to nogging at 150 mm centres.

CERTIFICATES



APPLICATION OF OSB



EGGER OS'Brace® high quality and environmentally sustainable structural bracing



EGGER OS'Brace® low emission in indoor applications



EGGER OS'Brace® H2 Blue used as web material for I-beams



EGGER OS'Brace® H2 Blue used as bracing in SIP-panels

ENVIRONMENT AND SUSTAINABILITY

FROM THE TREE TO THE PRODUCT – A CLOSED CYCLE

The closed life cycle of wood-based products is in the centre of our activities. In our mission statement we have allocated the sustainable use of raw materials the highest priority. EGGER therefore counts on fully integrated locations, where wood is initially used materially. This extends from the solid timber production in the sawmill, up to the production of wood materials such as laminate floorings.

WHAT ARE ENVIRONMENTAL PRODUCT DECLARATIONS (EPD's)?

EPD's contain all the environmental information, product-related information and test reports about a product in a central document. This means that the product is extensively described and the manufacturing process represented. EPD's fulfil the need for detailed declaration of building products over the whole life cycle.

They form the basis for the data for assessing buildings on an ecological level. EPD's are based on ISO Standards and are therefore internationally aligned. They are suitable as proof of environmental claims in the public procurement arena. The EPD's are verified and confirmed by independent experts and commissioned by the Institute Construction and Environment e.V., Germany.

A full version of the EPD is available at www.egger.com/environment/

Wood residues and recycled wood that cannot be used in production is utilised as thermal fuel in our biomass power plants. Through this, EGGER makes "more from wood" and substantiates this by Environmental Product Declarations (EPD) according to ISO 14025 for the whole product range of wood-based panels including OSB.

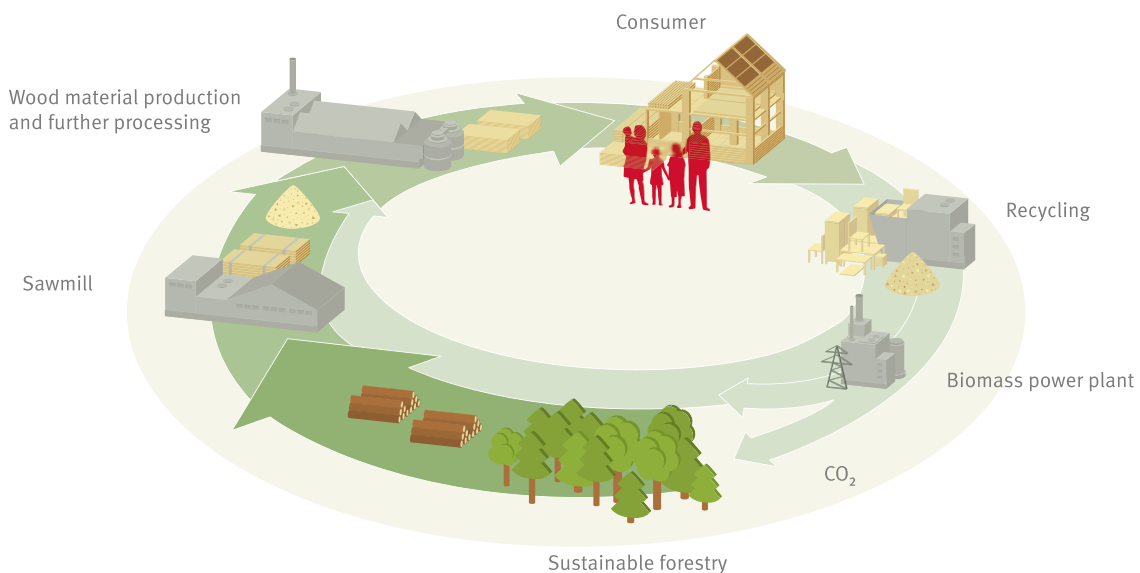

DELIVERY PROGRAMME

OS'Brace® and OS'Brace® H2 Blue – sheet dimension and weight

Size [mm]		Thickness [mm]	Piece/Pack	Area/Pack [m²]	Weight/Panel [kg]	Weight/Pack [tonne]
Length [mm]	Width [mm]					
2440	900	6	90	197.6	8.4	0.76
2440	1200	6	90	263.5	11.2	1.01
2745	900	6	90	222.3	9.5	0.85
2745	1200	6	90	296.5	12.6	1.14
3050	900	6	90	247.1	10.5	0.95
3050	1200	6	90	329.4	14.1	1.26

EGGER – THE EUROPEAN OSB PLANTS

The EGGER group is a 100 % family-owned business. Since its inception in 1961 in St. Johann i.T., Austria, EGGER has become a leading manufacturer of wood-based products on the European market. Today, EGGER has 17 plants in 7 European countries, about 6,800 employees, sales offices in all major industrial nations of the world and a global sales and distribution network serving over 85 countries worldwide.

Wismar (Germany) and Rădăuți (Romania) are Europe’s most modern production sites for EUROSTRAND® OSB and OS’Brace®. Wismar has direct access to the Baltic port. Both plants are linked with perfect logistic access to rail and truck and are surrounded by sustainably managed forests.

Our employees are highly motivated with a strong sense of quality and a desire to achieve customer satisfaction. Independence and stability is guaranteed by in-house energy supply and resin production.



Wismar (DE)



Rădăuți (RO)

- PRODUCTION SITES
 - SALES OFFICES
- | | |
|--|--|
| <ul style="list-style-type: none"> 1 ST. JOHANN IN TIROL AT 2 WÖRGL AT 3 UNTERRADLBERG AT 4 BRILON DE 5 BEVERN DE 6 GIFHORN DE 7 BÜNDE DE 8 MARIENMÜNSTER DE 9 WISMAR DE 10 HEXHAM UK 11 BARONY UK 12 RAMBERVILLERS FR 13 RION DES LANDES FR 14 SHUYA RU 15 GAGARIN RU 16 RĂDĂUȚI RO 17 GEBZE TR | <ul style="list-style-type: none"> 1 TOURS FR 2 ZULTE BE 3 TISTRUP DK 4 KRIENS CH 5 TREVISO IT 6 ŠENČUR SI 7 VARAŽDIN HR 8 HRADEC KRÁLOVÉ CZ 9 POZNAŃ PL 10 BUDAPEST HU 11 SMEDEREVO RS 12 SOFIA BG 13 BUCUREȘTI RO 14 İSTANBUL TR 15 VILNIUS LT 16 MINSK BY 17 KIEV UA 18 MOSCOW RU 19 SHANGHAI CN 20 TOKYO JP 21 NEW DELHI IN 22 SANTIAGO DE CHILE CL 23 MELBOURNE AU |
|--|--|

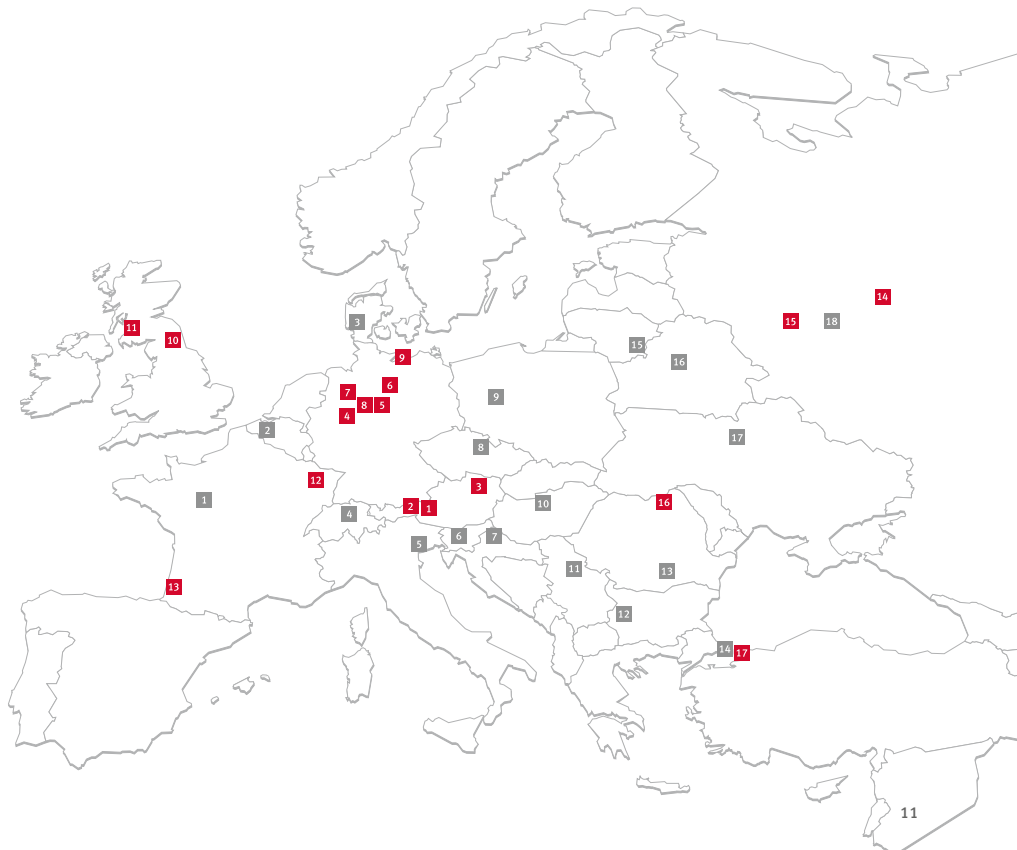

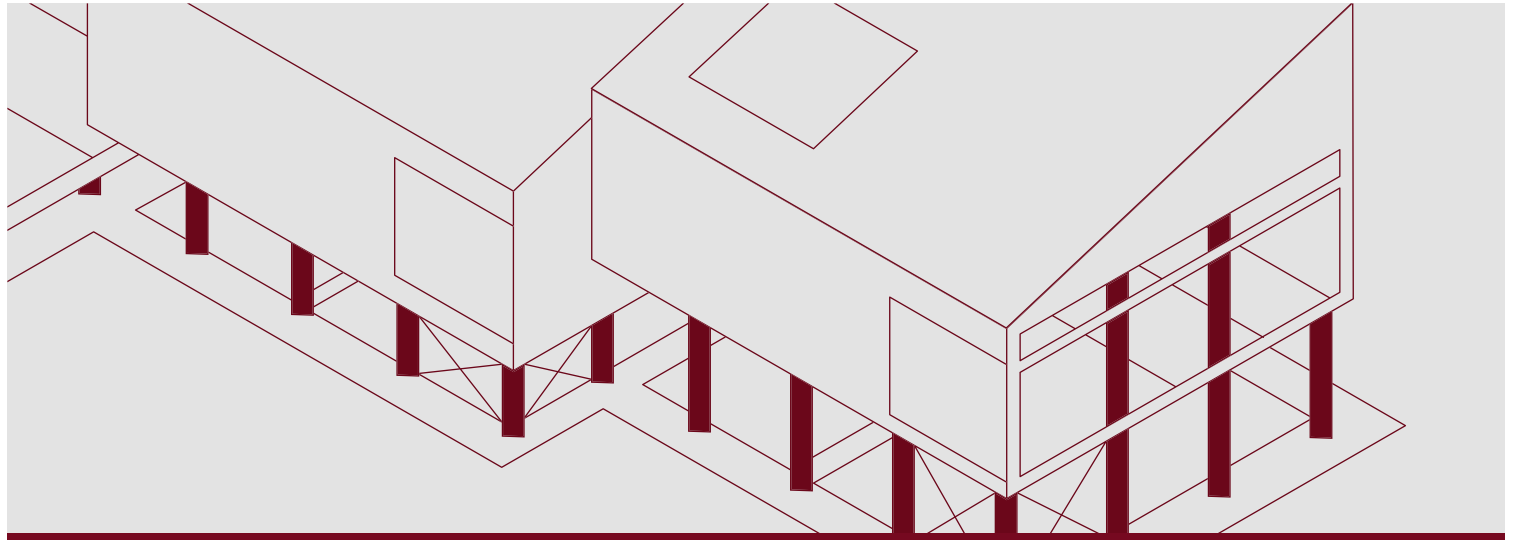

www.egger.com/osbrace

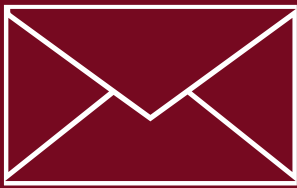

TECHNICAL SUPPORT

australia@egger.com

EGGER Holzwerkstoffe Wismar
GmbH & Co. KG
Am Haffeld 1
23970 Wismar
Germany
T +49 3841 301-0
F +49 3841 301-20222
info-wis@egger.com

EGGER AUSTRALASIA
PTY LTD
PO Box 697
Carlton South 3053 Victoria
Australia
T +61 448 200 013
australia@egger.com

SC EGGER România SRL
Str. Austriei 2
PO Box 38
725400 Rădăuți, jud. Suceava
Romania
T +40 372 438000
F +40 372 468000
info-rau@egger.com

available from: